

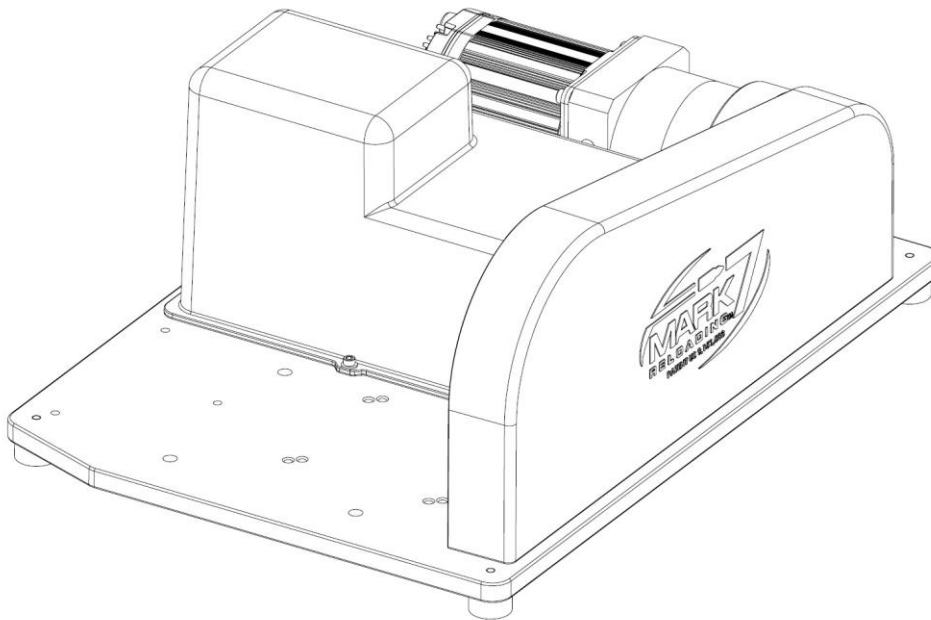

# Mark 7<sup>®</sup> 1050 PRO Autodrive User Manual v9.3

**(Supports Dillon 1050 Super, RL1050, RL1100 and  
CP2000 Presses)**



**Read this manual and the Dillon Precision Press Manual completely. Understand all safety and operating instructions. Failure to comply with the warnings and instructions may result in serious injury, illness or death.**

## Table of Contents

<b>Table of Contents</b> .....	2
<b>Important Safety Instructions</b> .....	3
<b>Box Contents</b> .....	6
<b>Set-Up Procedures</b> .....	7
1. Removal of equipment from the packing carton.....	8
2. Determine mounting holes for either Super 1050 or RL 1050 .....	9
3. Mounting large sprocket.....	10
4. Belt installation .....	11
5. Belt tensioning .....	12
6. Belt Guard installation .....	13
7. Removing the ratchet system on the 1050.....	14
8. Tablet holder install .....	15
9. Tablet cable outlet installation .....	17
10. Console Rear I/O inputs .....	18
11. Console Side I/O inputs.....	19
12. EMI FILTER for Bulletfeeders .....	21
13. EMI FILTER for Casefeeders .....	22
14. Recommended Cable management .....	24
15. Manully Driving the press .....	27
<b>Sensors</b> .....	28
<b>PRIMER</b> Sense® (Optional).....	28
DecapSense™ (Optional) .....	29
<b>SWAGE</b> Sense® (Optional).....	32
<b>BULLET</b> Sense® (Optional) .....	37
<b>POWDER</b> Sense® *original sensor attached to Dillon Powder Check (Optional) .....	51
1050 Safety Shield with Electronic Disconnect (Optional).....	53
Operating Instructions: 1050 PRO .....	56
Software Firmware Updates .....	63
Autodrive Maintenance Intervals .....	69
Dillon 1050 SUPER Lubrication Points.....	69



Storage Recommendations..... 70

Reloading Manual ..... 71

Ensuring proper system operation ..... 71

Calibration..... 71

Test Rounds..... 71

Digital Clutch Setting..... 72

**JAMSense**® ..... 73

Communications Errors ..... 75

Troubleshooting ..... 76

## Important Safety Instructions

Read this manual completely prior to installation and operation. Understand all safety and operating instructions. Failure to comply with the WARNINGS and instructions may result in serious injury or death. WARNINGS throughout this manual will be symbolized by the yellow WARNING symbols seen below.



**WARNING** – Activities using the Mark 7® 1050 Autodrive are inherently dangerous and may lead to injury and even death. Actions as a result of using the Mark 7® product are solely the responsibility of the user – if you get injured through the reloading process or through the use of ammunition as a result of the reloading process it is your fault.



**WARNING** - Mark 7® equipment should only be operated by trained personnel that follow all safety precautions. Failure to do so could result in serious injury or death.



**WARNING** - This product is designed to be used by reloading personnel in conjunction only with a fully functioning and well lubricated Dillon 1050 reloading press. Its use should be limited to experienced personnel only. All personnel using this equipment are assumed to have prior experience setting up and operating a Dillon 1050 reloading press. This document contains basic operating and maintenance instructions only.



**WARNING** - Never leave your Mark 7<sup>®</sup> Autodrive unattended while it is operating.



**WARNING** – Never run the Mark 7<sup>®</sup> Autodrive without the belt guard fully attached to the baseplate.



**WARNING** – Never operate the Mark 7<sup>®</sup> Autodrive unless it is completely within Dillon Precision factory specifications and is operating within factory parameters. This includes the shell plate locating pins and other machine-specific features. Read and understand the latest Dillon Precision 1050 manual for your make and model machine and ensure that you fully understand the Dillon directions.

Never operate the Mark 7<sup>®</sup> Autodrive with any third party accessories that substantially change the operation of the Mark 7<sup>®</sup> Autodrive



**WARNING** – Never operate the Mark 7<sup>®</sup> Autodrive while impaired.



**WARNING** – Never operate that Mark 7<sup>®</sup> Autodrive without using high quality brass and always use sufficient lubrication on your brass while operating the Mark 7<sup>®</sup> Autodrive.



**WARNING** – The Mark 7® Autodrive is designed to help automate the process of loading and processing of ammunition. Never operate the Mark 7® Autodrive at speeds higher than you have tested and are comfortable with for the type of reloading or processing that you are undertaking. Run the Mark 7® Autodrive at the slowest possible setting to create quality ammunition.



**WARNING** – Always wear protective eyewear to protect eyes from being injured. Flying debris may result when using this equipment. Always wear protective clothing that covers arms, legs and neck to protect from injury.

It is the responsibility of the user to insure that appropriate protective clothing and equipment are used to provide protection from those hazards to which personnel are exposed or could be exposed while working with this product. Failure to do so could result in serious injury or death

## Box Contents

Please review these contents and inform us right away if you appear to be missing any of these items:

**Main:** Mark 7® 1050 PRO AutoDrive Assembly (1 item)

### Lower Insert:

**Left Side:** Power Cable (1 item)

**Right side:** Pocket 1: Large Sprocket and Cap (2 items)

Pocket 2: Hardware (16 items)

- Link Bar
- ¼-20 hex head bolts (4X)
- ¼-20 lock washers (4X)
- ¼-20 socket head (2X)
- 3/8-24 X 1.25" Set screw (1X)
- 3/8-24 hex nut (1X)
- 10-32 Thumb Screw (3X)
- RL Hardware Kit

### Middle Insert: (6 items)

- Cable management (zip ties, zip tie mounts) (4X each)
- Tablet holder with 4X right angle inserts and plugs (1X)
- Tablet mount (1X)
- Micro-USB Cable (1X)
- EMI Filter kit for case feeder and Bulletfeeder (1X)
- MicroSD Card for software updates (1X)

### Top Insert: (4 items)

- Tablet (1X)
- Belt (1X)
- Belt guard (1X)
- Setup instructions (1X)



## Set-Up Procedures

The Mark 7® Autodrive is manufactured with superior craftsmanship and quality that is backed by a factory warranty.



**WARNING** -Only use Mark 7® accessories with the Mark 7® Autodrive. Mark 7® equipment is prepared and tested by Mark 7® prior to delivery. To place the equipment into service, please review the following instructions carefully.



**WARNING** - In order to ensure proper operation and avoid damage to your press perform the pre-installation steps.

**Prior to installation perform the following manual press checks and adjustments (see Dillon Precision Super 1050 Manual for location of some of the items below):**

1. Ensure that the press/autodrive combination is on a very solid surface that does not move. The Mark 7 autodrive is designed to sit on the 4 rubber feet in the corners, but it can also directly bolted to your work bench by removing the 4X rubber feet in the corners, use ¼-20 bolts to fasten the baseplate to the work surface from underneath. Small vibrations can have an unpredictable impact on the operation of the machine. Ensure that the machine does not move whatsoever when operating.
2. Always have your loader grounded to a high-quality grounding line.
3. Ensure that the press operates according to Dillon Precision specifications before you install the autodrive. **Any modifications to your machine outside of the Dillon standard configuration and parameters will void the Mark 7® warranty.** Ensure that the shell plate retaining collar is adjusted so that the shell plate turns freely but is not too loose. Ensure that the index pawl enables the shell plate to move completely from one index position to the next. Refer to the press user's manual for the location of the pawl adjustment screw. Verify that the alignment pins pass cleanly into their respective holes and are not used to complete the index motion.
4. Check that there is no powder or other debris under the shell plate. Lubricate the press as described in the Dillon Precision user's manual. Keep the shell plate clean.
5. There will likely be three (3) cables coming from the machine: the power to the case feeder, bullet feeder, and autodrive. **For best performance we recommend to keep the case feeder and Mr.Bulletfeeder cables separated from our system cables if possible.**

## 1. Removal of Main Autodrive assembly from the packing carton

Upon removal carefully inspect contents for damage. Damage that occurs during shipment should be reported immediately to the carrier. Major system components listed below

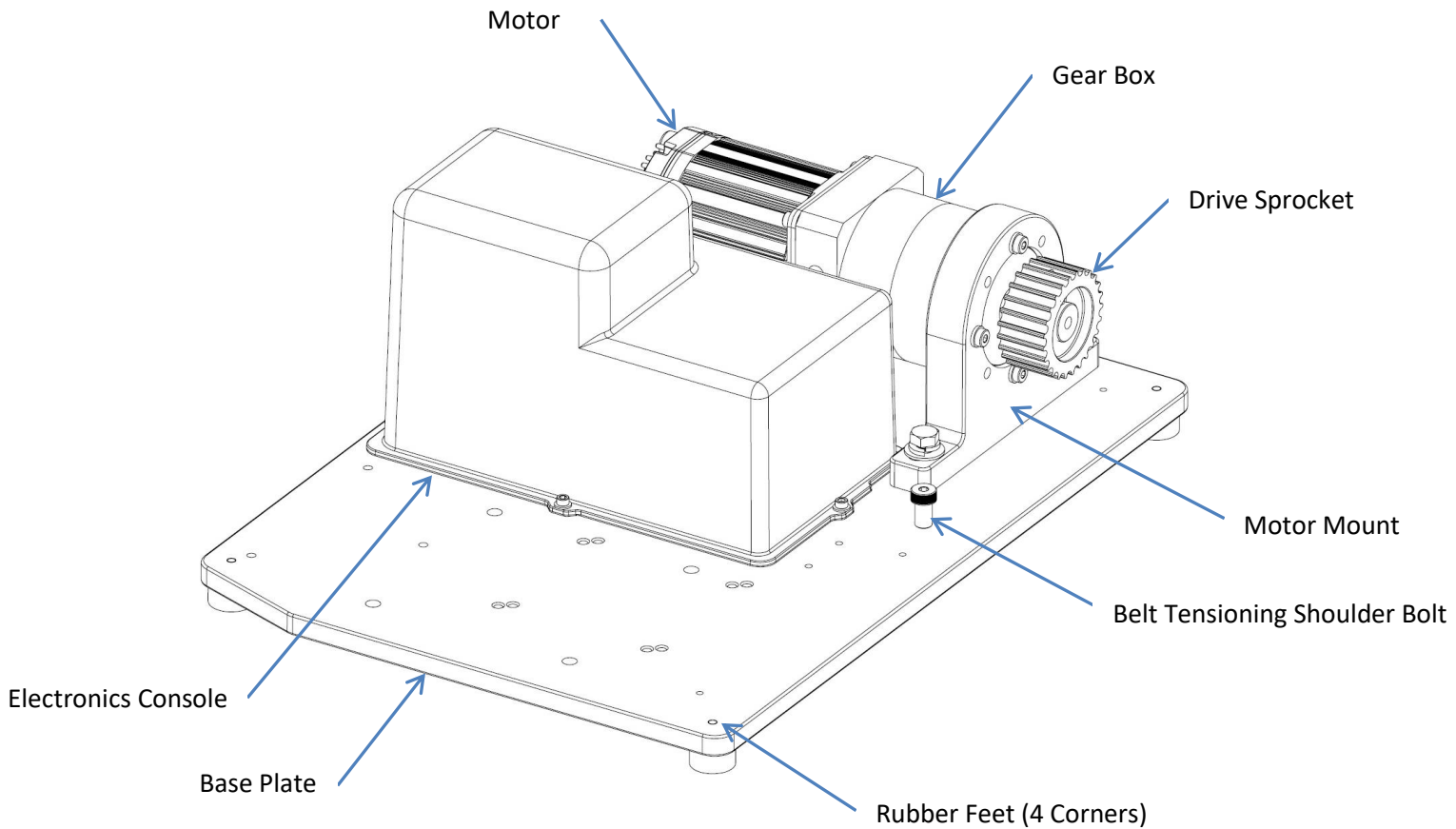
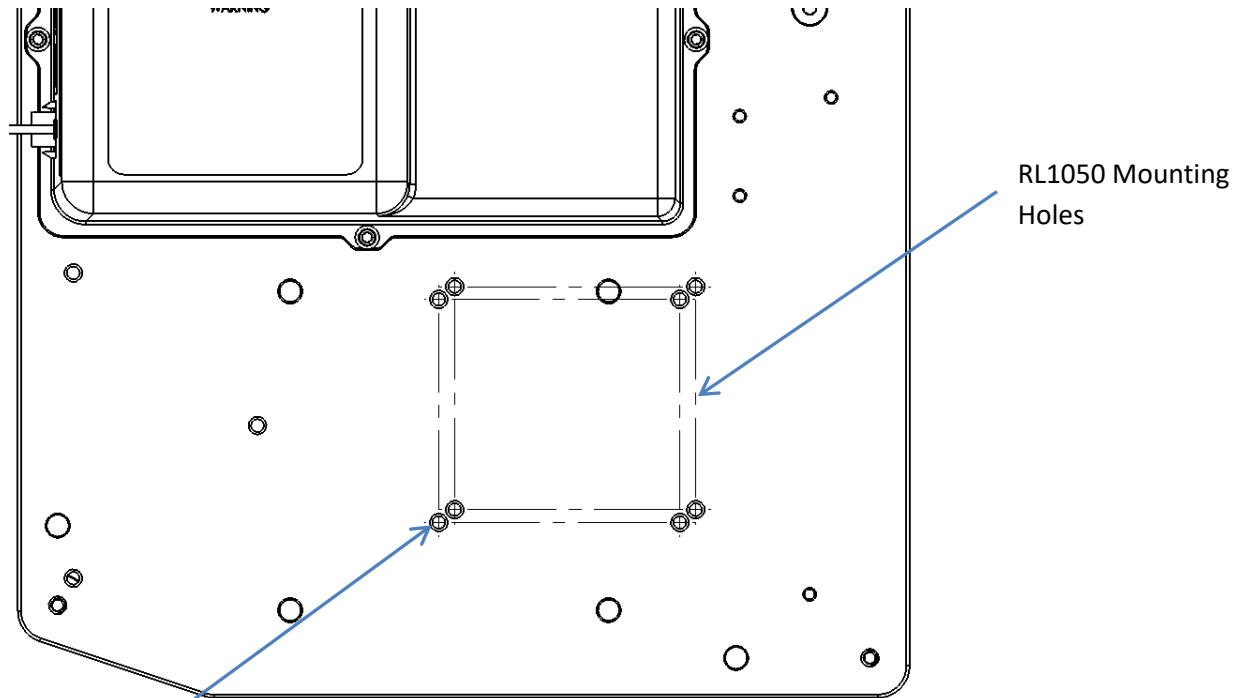

Figure 1: Major Component Overview





## 2. Determine mounting holes for either Super 1050/RL 1050/RL1100/CP2000



Super 1050/RL1100/CP2000  
Mounting Holes

Figure 2: Mounting Location on baseplate for RL and Super

Depending on whether you have a Super 1050/RL 1100/RL 1050/CP2000 there are specific mounting holes for each. You can see in the picture above the two sets of four holes each. When mounting the press to the baseplate, thread all four bolts into the baseplate before final tightening (RL1100/CP2000 uses the longer bolts). Torque the  $\frac{1}{4}$ -20 screws to 4-5 ft. lbs. (5.5-6.5 Nm). For RL 1100 use longer  $\frac{1}{4}$ -20 X 1-7/8" screws from RL 1100 Hardware Kit provided.

The mounting holes in the Super 1050/RL 1100/CP2000 are the closest to the front of the baseplate and the holes for the RL 1050 are the farthest.

Be mindful not to drag the bottom of the press against the baseplate. We recommend that you place the bottom of the press as close to the mounting holes as possible in order to avoid unnecessary scratches to the anodized finish of the baseplate.

Once mounted articulate the handle so that the press is at the top of stroke and proceed to loosen and remove the set screw that holds the handle in place.

### 3. Mounting large sprocket

There are two sets of holes in the sprocket; one set for the Super 1050 and one set for the RL1050/RL1100/CP2000. **Indicator must be at 12:00 position.**

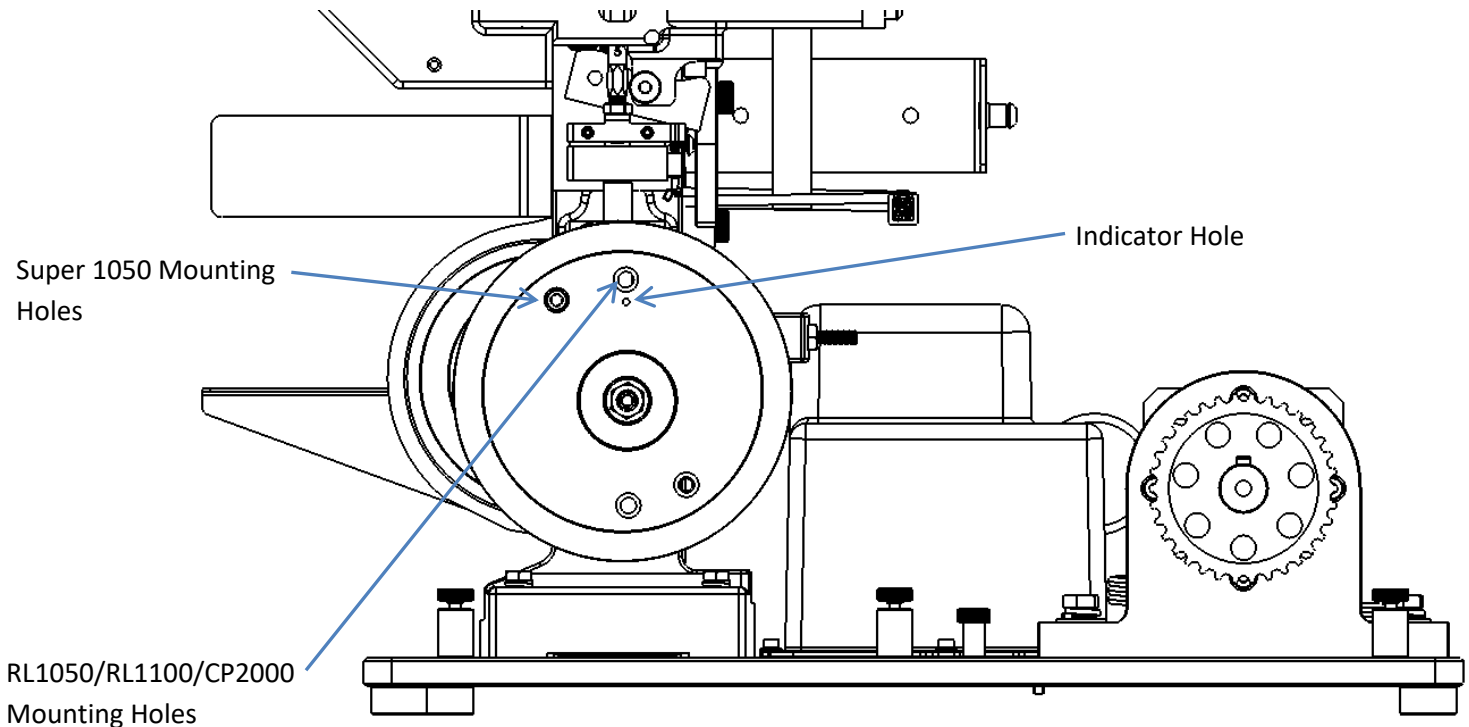

Figure 3: 1050 fastened to baseplate with large sprocket installed

**Make sure the toolhead is in the UP position.** Remove the lever and slide the large sprocket onto the 1050 input shaft as seen in the photo. **Position the sprocket so the label is upright and indicator hole is at the top. The center sprocket hole is ECCENTRIC, if the sprocket is mounted upside down the belt will not tension properly and will loosen during the stroke.** Next insert the link bar and rotate the sprocket so the correct pair of holes lines up with the link bar. The indentation under the hole is for the 1050 RL and 1100 RL and the hole without an indentation is for the Super 1050 press.

Thread in the long  $\frac{3}{8}$ -24 set screw into the 1050 input shaft in order to pinch the link bar.

Then insert the sprocket cap and fasten with the  $\frac{3}{8}$  nut. Torque to 4-5 ft lb (5.5- 6.5 Nm).

Torque both  $\frac{1}{4}$  -20 screws 4-5 ft. lbs. (5.5-6.5 Nm).



#### 4. Belt installation

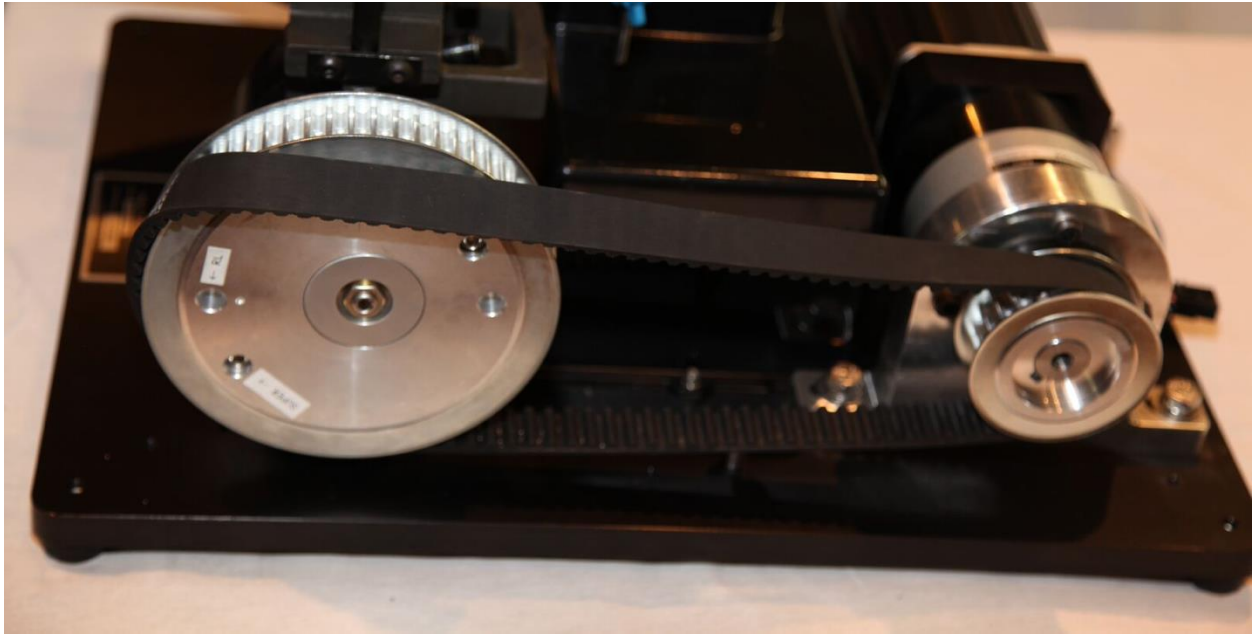

Figure 4: Installing belt on large Sprocket

Loosen both motor mount hex bolts with a 9/16 wrench. Then rotate the large sprocket counterclockwise so that the press is in the full down stroke position.

Place belt over small sprocket making sure motor mount is all the way forward. Loop belt under bottom section of large sprocket and rotate the large sprocket clockwise to properly seat the belt.

**WARNING** 

The press may rotate back to the up position so you may need an assistant to hold it in position.





## 6. Belt Guard installation



Figure 6: Belt Guard Installed (RL 1050/Super 1050)

For the 1050 RL and Super 1050 fasten the belt guard to the baseplate using the 3X 10-32 Thumb screws. Do not over-tighten.

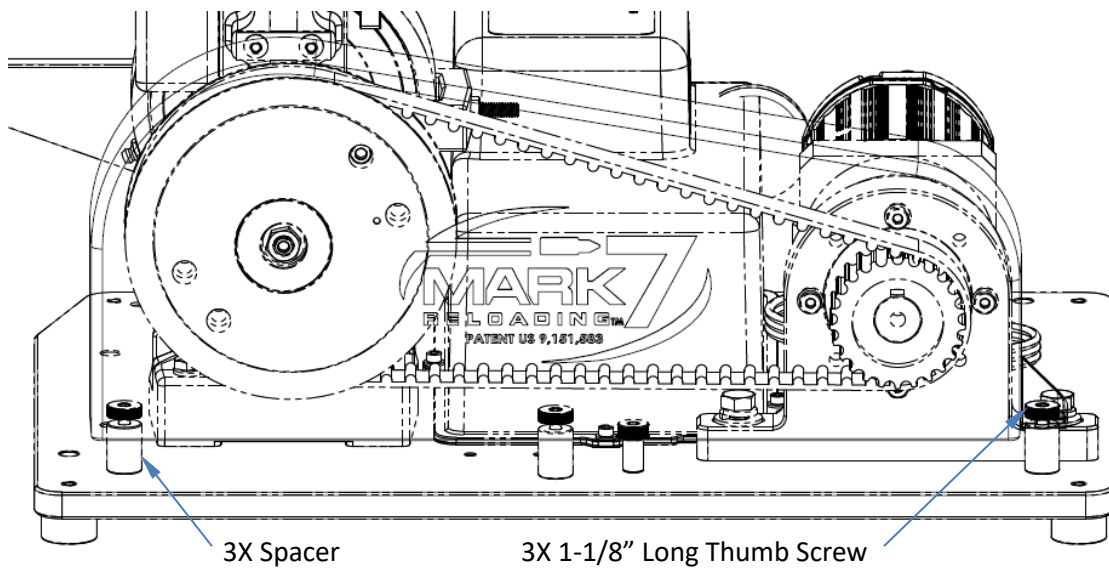



Figure 7: Belt Guard Installed (RL 1100/CP2000)

For RL 1100/CP2000 use 3X 7/8" high Spacers and 3X 1-1/8" long Thumb Screws from Hardware Kit provided.

**WARNING**  Never operate the machine without the belt guard installed properly.



## 7. Removing the ratchet system on the Super 1050/RL 1100/RL 1050

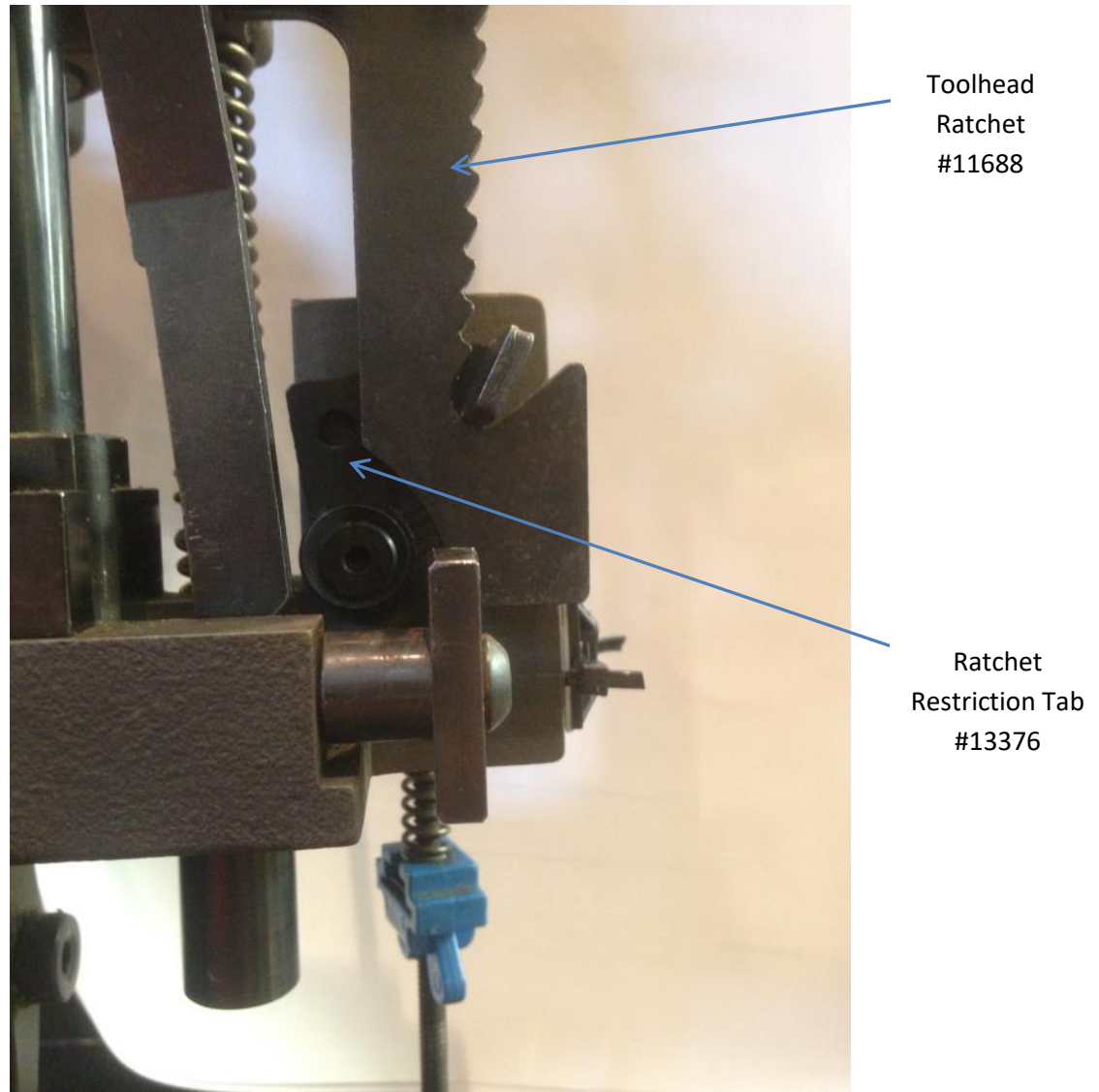
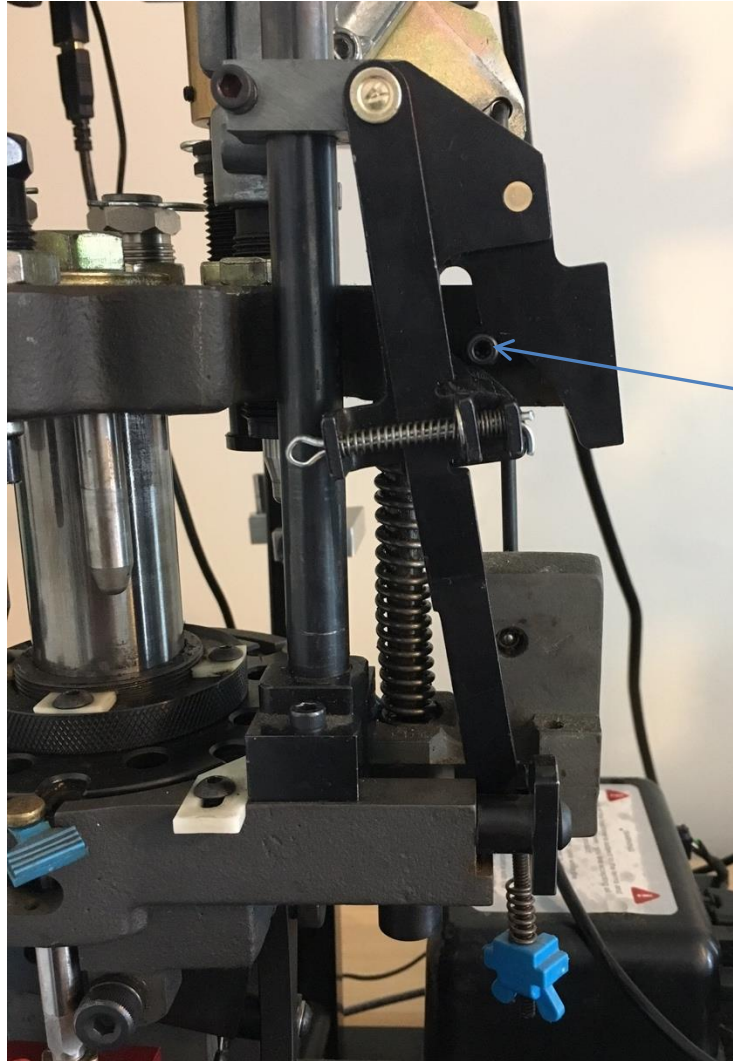

Figure 8: Removing Ratchet arm

In order to use the Jog functionality of the Mark 7<sup>®</sup> Autodrive the ratcheting system on the Dillon must be removed – but that is a decision best made by the user. You can either choose to remove the ratchet arm Dillon Part #13376 or the toolhead ratchet Dillon Part #11688 or both (recommended) as shown above. **If you remove the ratchet plate make sure to re-install the Cam Guide Bolt Dillon Part # 12486 shown in Figure 8.**



Re-install Cam  
guide bolt  
#12486

Figure 9: Ratchet mechanism removed

**WARNING** 

If you remove the ratcheting system please be very careful to not over or under index the machine – double loads and squibs can occur as a result of this situation and it is your responsibility to know when the press has created this situation. An example is: the digital clutch engages at the bottom of the stroke –a primer is already inserted in one case and powder in another. Jog Up or manually clear the shellplate to fix the jam and then activate Run on the press. This would create a potentially dangerous situation. The correct resolution of this is to turn the press off, remove the power cord. Manually manipulate the press to fix the impacted areas, clear the press, and start the loading process again while discarding the affected rounds.

## 8. Tablet holder install

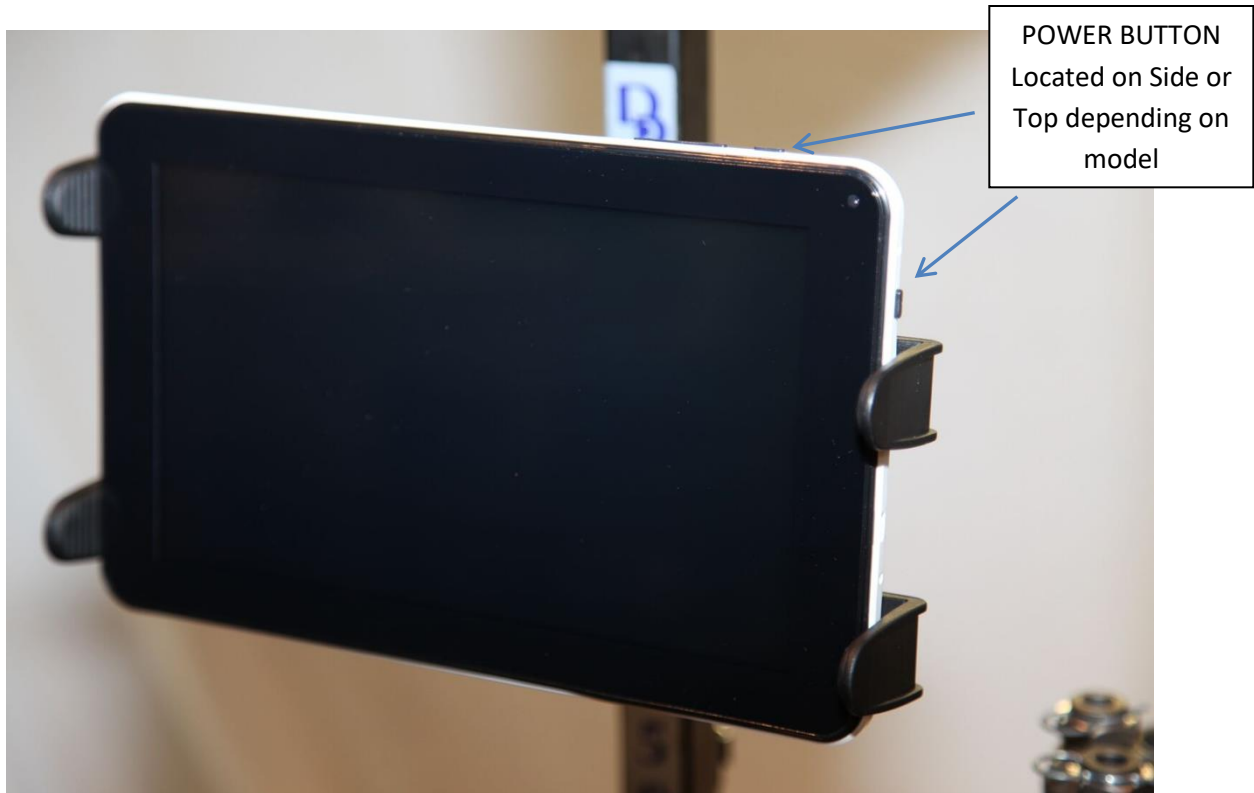

Figure 10: Tablet Installed in holder

Attach tablet holder arm to the tablet holder. The tablet holder will make a positive clicking sound when it is seated correctly. Once attached, clamp tablet holder arm to brass feeder post at the desired position. To power tablet, press and hold the button on the upper right side of the tablet.

Once tablet holder is positioned correctly, carefully pull tablet holder laterally (for 7" and 9") to expand enough to accommodate tablet as seen in picture. Be mindful that the arms do not cover the power or the micro-USB inputs on the tablet.

### WARNING

Ensure that the cables are coming from the tablet to the right of the unit. They should not interfere with the operator's vision of the unit and are completely out of the way of the operation of the unit. **Do not zip tie the tablet cables to Dillon case feeder pole, case feeder power cord or Mr. Bulletfeeder power cords.**



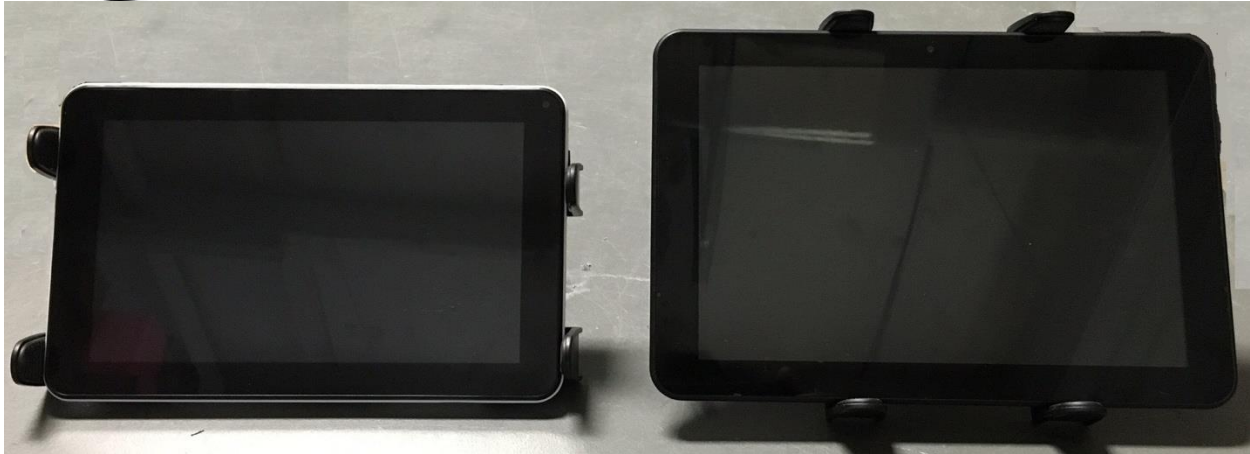

Figure 11: Tablet Holder orientation for 9 inch tablet (left) Upgraded 10 inch (Right)

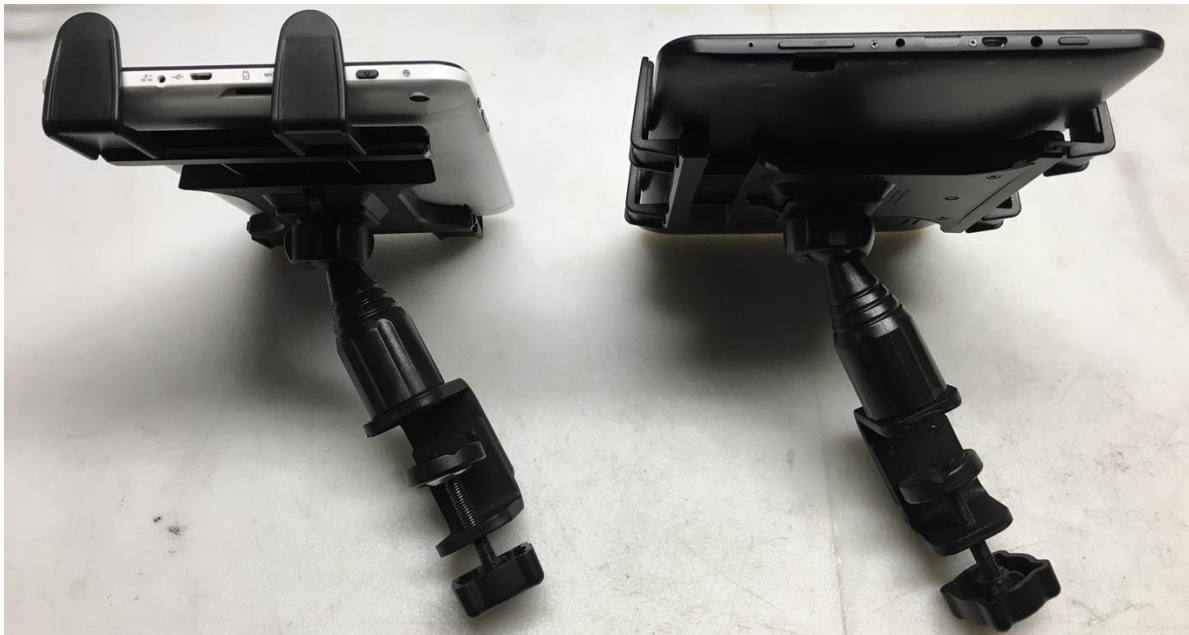

Figure 12: Side view of Tablet holder 9 inch (left) Upgraded 10 inch (Right)

Once tablet holder is positioned, carefully pull tablet holder to expand enough to accommodate tablet as shown above. Be mindful that the arms do not cover the power or the micro-USB inputs on the tablet. There are 2 sets of right angle adapters, the short adapters are used on the 7" and 10" tablets and the longer adapters are used on the 9".

## 9. Tablet cable outlet installation



Figure 13: Tablet Connections (connections may be on top for some tablet models)

Locate and the insert power cable into the tablet's power jack located directly below the Micro-USB. Insert Micro-USB into the input located directly above the power jack. The Micro-USB provided with the machine may be different from the picture above as the new version is a 1 piece micro-to-micro usb cable that can be installed in any direction. The original Micro-USB cable is a 2-part assembly, **the short adapter with the tablet label plugs into the tablet. The long portion of the cable plugs into the console; see section 11 or port location. The USB CONNECTION WILL ONLY WORK PLUGGED IN THIS ORIENTATION.**



**WARNING** -The operator of the press should always stand in front of the machine, facing the tablet with hands near the tablet to press the STOP button in the event the press needs to stop. You should visually see the decapping die spent primers and watch for bullets toppling or powder spilling. The best vantage point for this is standing immediately in front of the press.



## 10. Console Rear inputs



Figure 14: Rear of console Inputs

**Before powering on the Mark 7 Units please make the following connections**

Micro-USB: Tablet to Console USB data communication cable

USB: Motor to Console USB data communication cable

8-Pin: Motor to console signal cable

Port #7. **POWDERSense**\*original sensor attached to Dillon Powder Check (optional)

Port #6. 1050 Safety shield and Wired Remote Stop (optional)

Port #5. DecapSense™ Sensor (Optional)

## 11. Console Side inputs

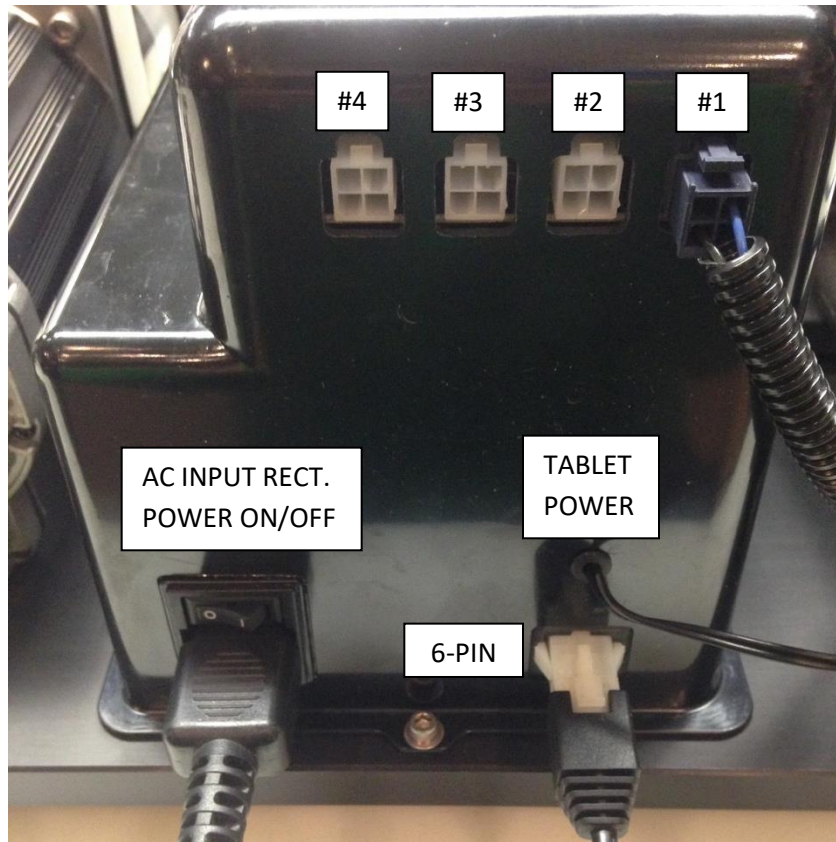

Figure 15: Side of Console Inputs

Port #4. **Mark 7® PowderCheck™ Sensor** (Optional)

Port #3. **BULLETSense®** (Optional)

Port #2. **SWAGESense®** (Optional)

Port #1. **PRIMERSense®** (Optional)

**AC INPUT & Power ON/OFF Receptacle:** Units are configured in either 110V or 220V.

**6-Pin:** Motor to Console DC Power Cord

**Tablet Power Cord:** Connect to tablet

### WARNING



Never power on the console switch without the 6-pin molex connector plugged in and never install this connector with the power already on since the DC voltage would damage the motor's input contacts.



## 12. EMI Filter for Mr. BulletFeeder and GSI Bulletfeeder Users

There is an external capacitor cable assembly included with your Mark 7® Autodrive. Ensure that this is attached to the bullet dropper assembly between that assembly and the cables to the bullet feeder to ensure error-free operation. Note: A modification may be required to install the filter on the GSI feeders.



Figure 16: Mr. Bulletfeeder filter (Double Alpha)



### 13. EMI Filter for Dillon Case feeder

We have found some of the brushed AC motors and microswitches in the Dillon case feeder produce more noise than others. If your system is experiencing electrical interference we recommend installing the RC filter and microswitch Assy. The RC filter provided is pre-crimped with spade terminals to minimize the installation. It plugs directly into the Dillon case feeder on/off switch. No wiring cutting or special tools required.

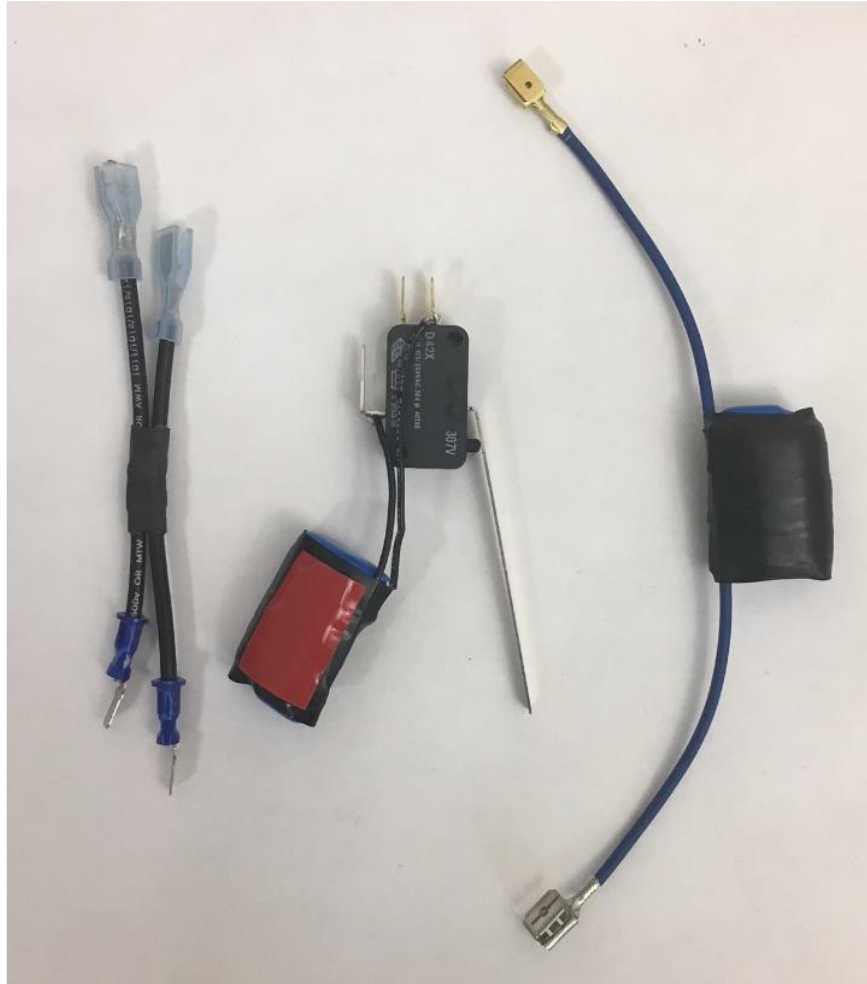

Figure 17: Case Feeder RC Filter



**WARNING** – Use of the RC filter is at your risk and only for those experienced with electrical systems and is only for the systems that are experiencing interference\*.



**Installation Procedure – for later model, U.S. case feeders. (1050 Super and RL 1050 only)**

1. Unplug the power cord to the Dillon case feeder.
2. Using a ¼ socket or nut driver remove the front cover plate on the case feeder. Remove and replace the microswitch with the filtered microswitch included in the kit.
3. Plug the RC filter into the microswitch as shown below and into the center position of the on/off switch. Plug the Power lines into the corresponding male terminal leads on the RC filter terminals as shown below.
4. Reinstall cover plate and test for proper operation.

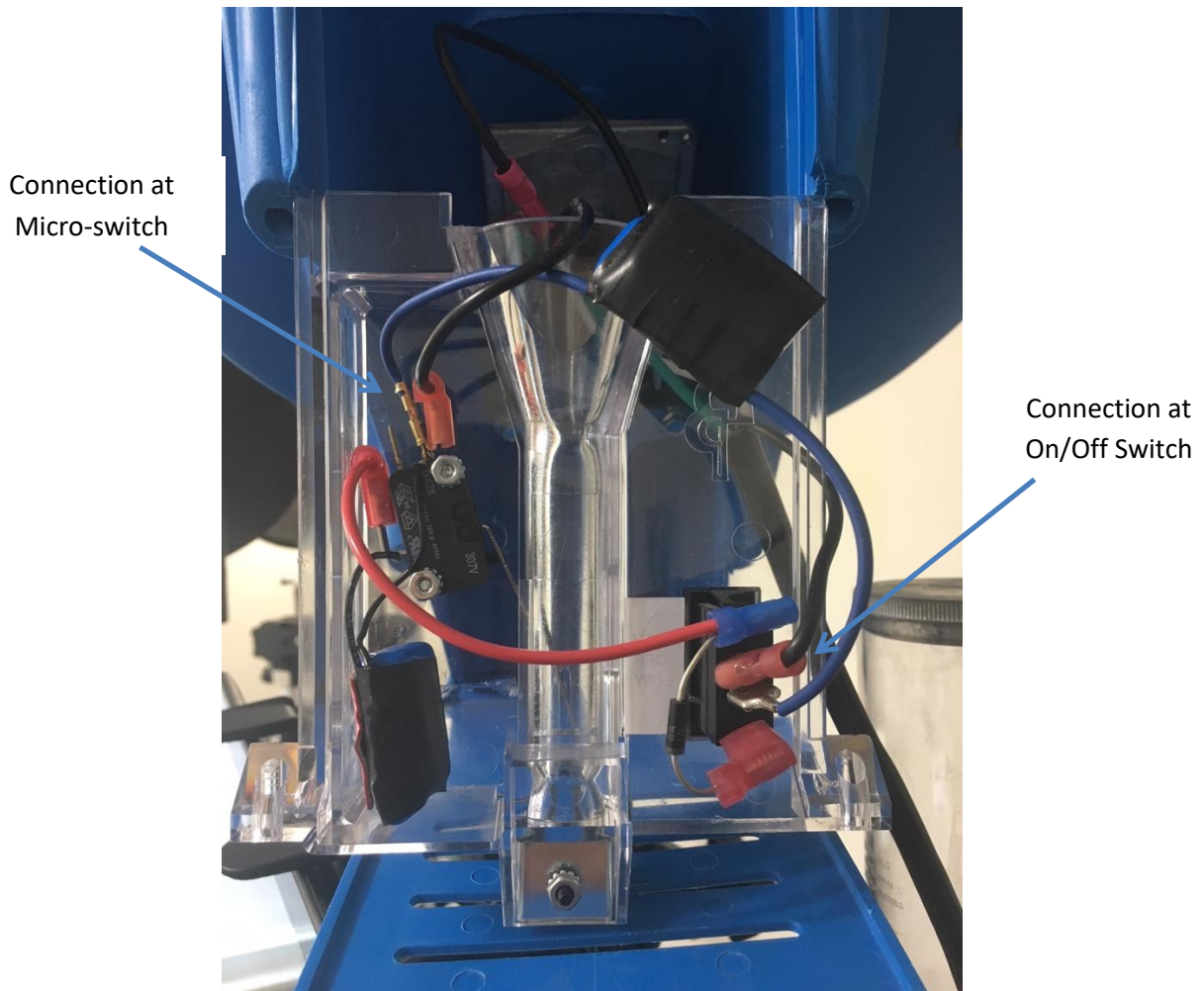

Figure 18: Case Feeder RC Filter

## 14. Recommended Cable Management

We recommend the following cable management in order to achieve optimal system performance and reduce the likely hood of electrical interference.

- Install EMI filters to the Case feeder and Mr. Bulletfeeder
- Do not tie ANY cables to the Dillon case feeder pole.
- Keep the Dillon case feed power cord and Mr. Bulletfeeder power cord away from the Table power and data cables.
- Mr. Bulletfeeder controller should be mounted away from the tablet and not to the case feeder pole.

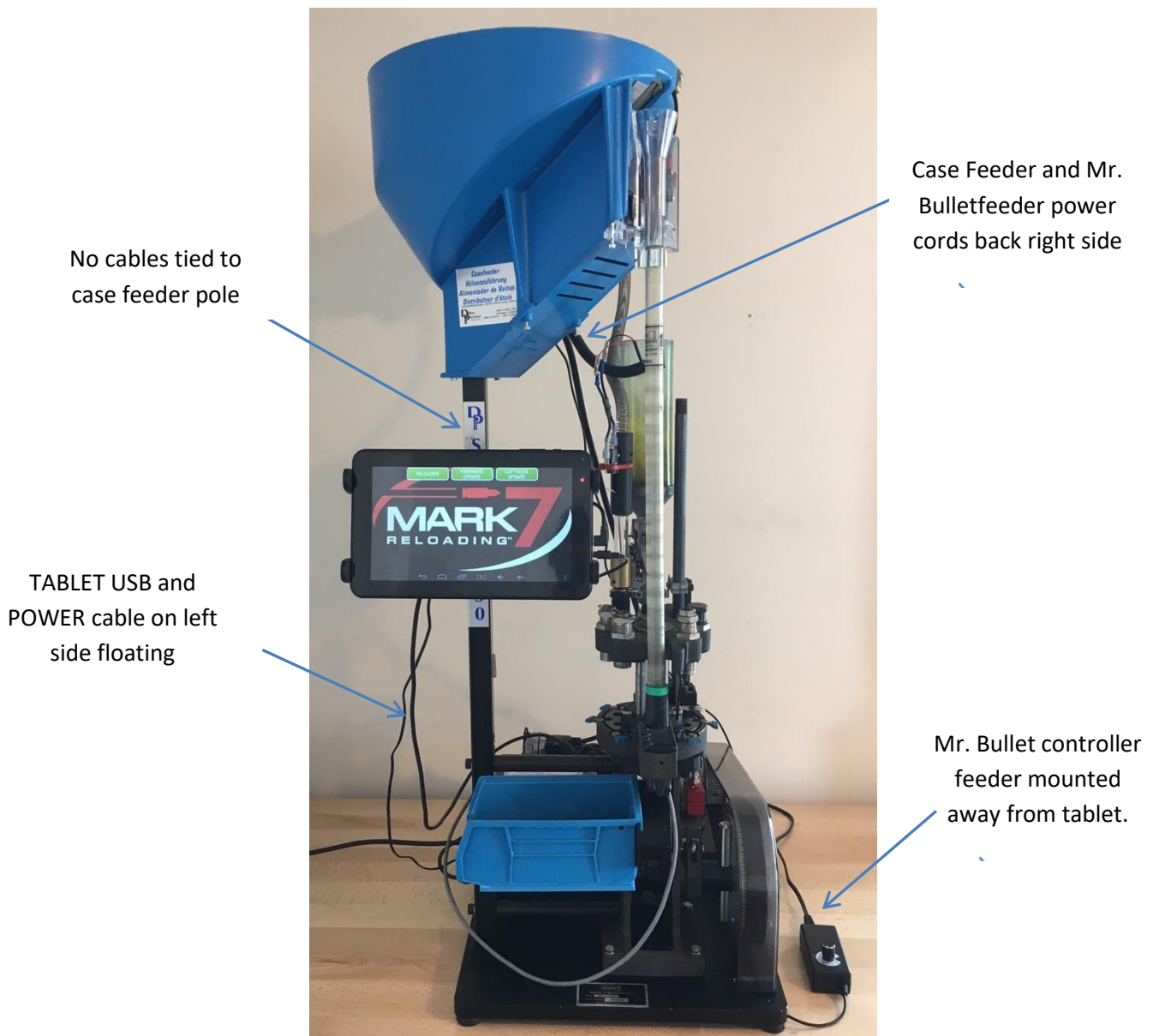
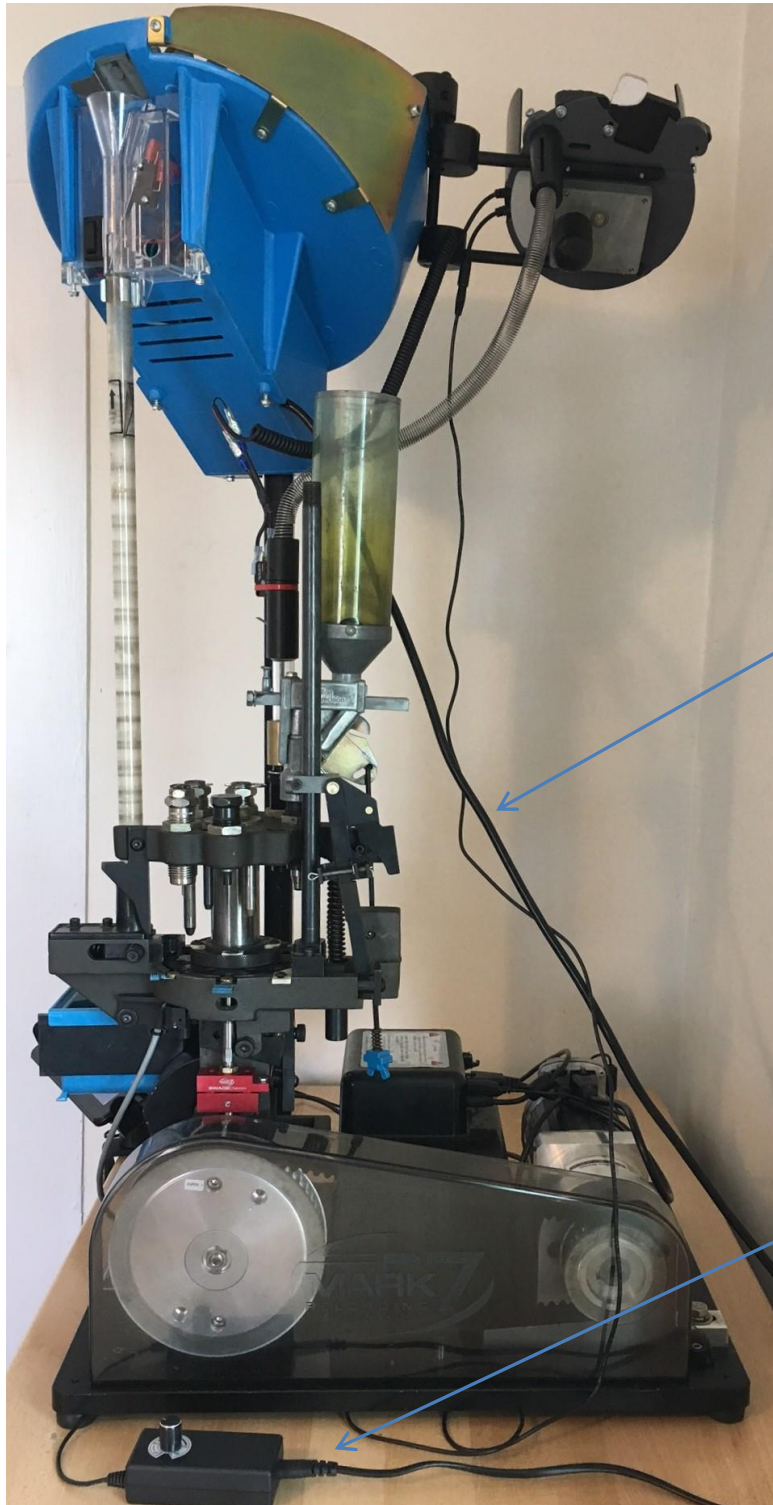

Figure 19: Recommended cable management front view





Case Feeder and Mr. Bulletfeeder power cords coming straight back away from machine.

Mr. Bullet feeder controller mounted to the side or behind machine

Figure 20: Cable Management Side View



Figure 21: Remote Tablet Mount (Optional)



## 15. Manually Operating the 1050 Autodrive

Once the autodrive is fully set up and electrically connected, we recommend to manually operating the 1050 a full stroke to make sure before powering the system on. To manually articulate the Dillon 1050 press use a 5/8" open end wrench on the Sprocket as shown below. Manually driving the press is also helpful to determine the cause of press jam during machine operation.

**Check the following with a clear shell plate before powering on the machine:**

- 1050 Toolhead moves the full stroke with no change in resistance
- Belt tension is consistent throughout the full stroke
- Belt tracking is consistent thought the full stroke.
- No cables are near the moving parts of the 1050, secure any loose cables away from the moving components



Figure 22: Manually driving the 1050 Press



## PRIMERsense® Installation Instructions

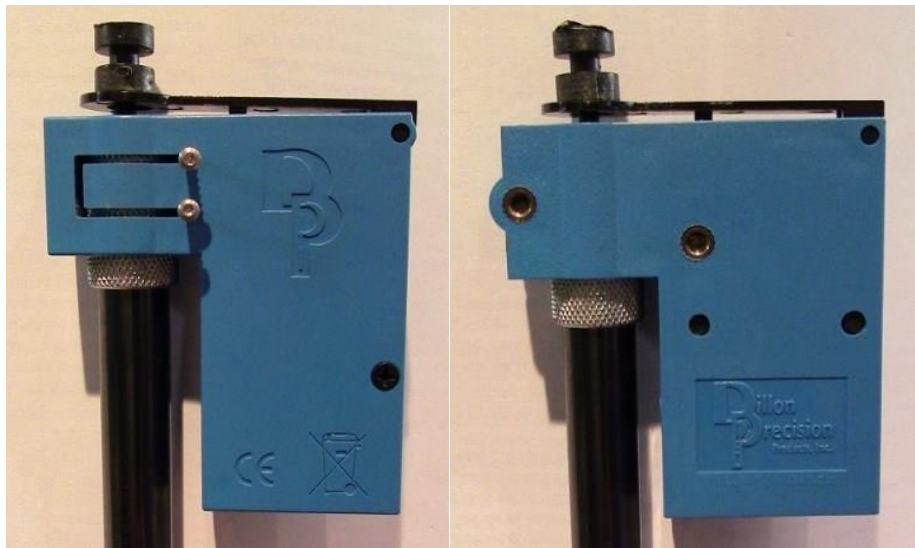

Figure 23: New Style Left, Old Style Right

The Low primers Sensor mount works with both the new and old style Dillon low primer alarms. Mounting on the new style primer alarm requires a Torx screws that thread into existing holes in side. Mounting for the old style requires replacing the bottom 8-32 screws with the screws supplied with the mount as shown in the figures below.

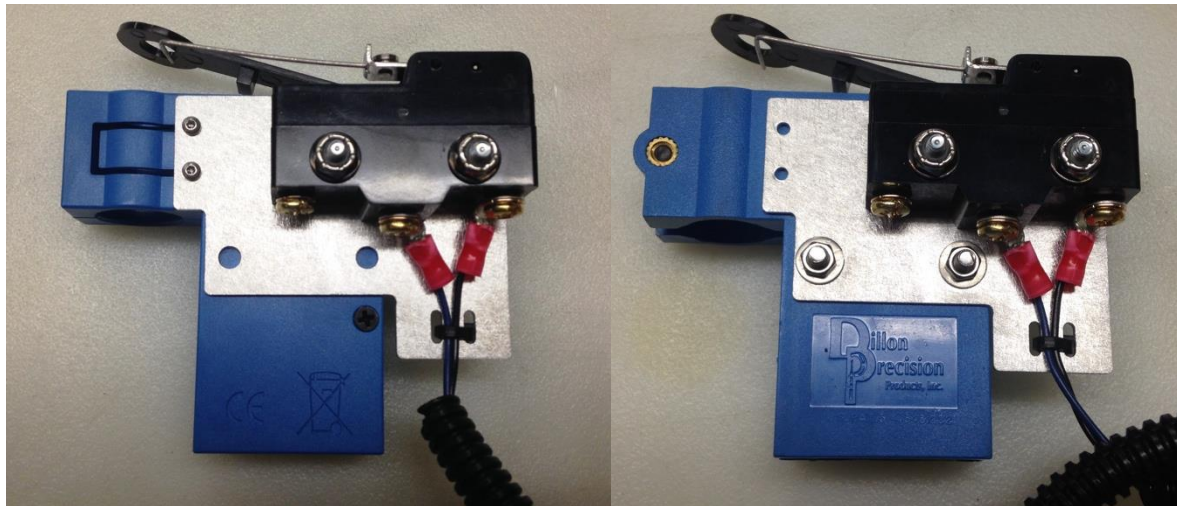

Figure 24: New Style mounted Left, Old style Mounted Right

It may be required to bend up the arm on the micro switch and to add a weight to the primer follower



## DecapSense™ Installation Instructions



WARNING –Use of the Mark 7® **DecapSense™** is at your risk and only for expert reloaders.

The Mark 7® **DecapSense™** is designed for both the Dillon 1050 Super and Dillon 1050 RL machines. Please confirm you have received the correct mount:

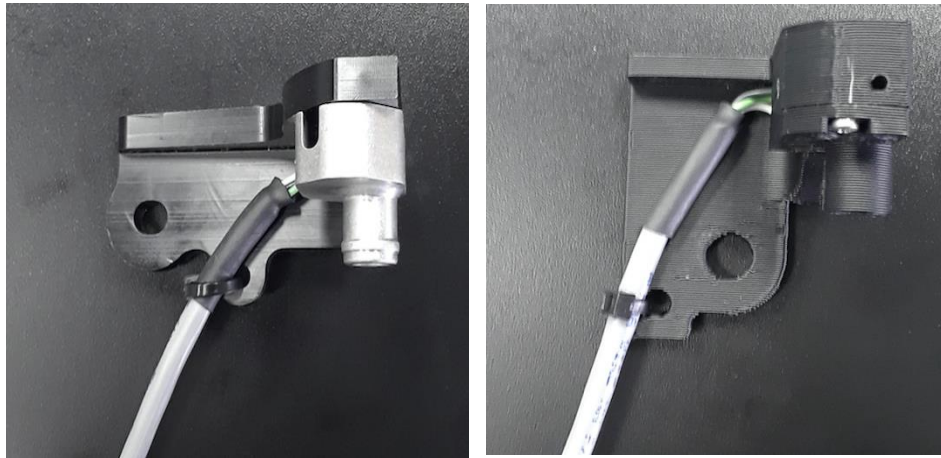

Figure 25: 1050 SUPER/CP 2000, RL 1100 (left) and RL 1050 (Right) DecapSense™

The Mark 7® **DecapSense™** package includes:

- Mark 7® **DecapSense™**
- 10-24 X 1/2" Pan head screw and washer for Super
- 1/4"-20 X 1/2" Pan head screw and washer for RL
- 3/8" ID PVC Clear tubing
- Wire management cable tie and bracket with adhesive backing

### DecapSense™ Installation Instructions

1. Remove the spent primer bin and bracket on the 1050.
2. Install the Mark 7® **DecapSense™** and check for proper fit/alignment. We recommend partially fastening the Mark 7® **DecapSense™** to the 1050, remove the sizing die and visually check

alignment and run an allen key through the decapping hole to ensure alignment and fully fasten. Remove allen key before continuing. Due to variations in the 1050 casting some filling/sanding may be required on the mount to ensure proper alignment.

3. Attach the hose and route into a bucket or other spent primer collection container.
4. Plug the Mark 7® **DecapSense** into the connector on the console at port#5 as shown in section 10.

### DecapSense™ Operating Instructions

1. Enter the Reloader application, check for software version 00.00.03 firmware 0006 at wavier screen (or newer, 1050-X only). All 1050 LTE & PRO SW/FW is compatible. Note: the Mark 7® **DecapSense™** must be connected before you enter or it will be disabled.
2. Calibrate and run the machine as normal. When a spent primer is not ejected the following notification box will appear. After you rectify the issue press okay and proceed with normal operation.

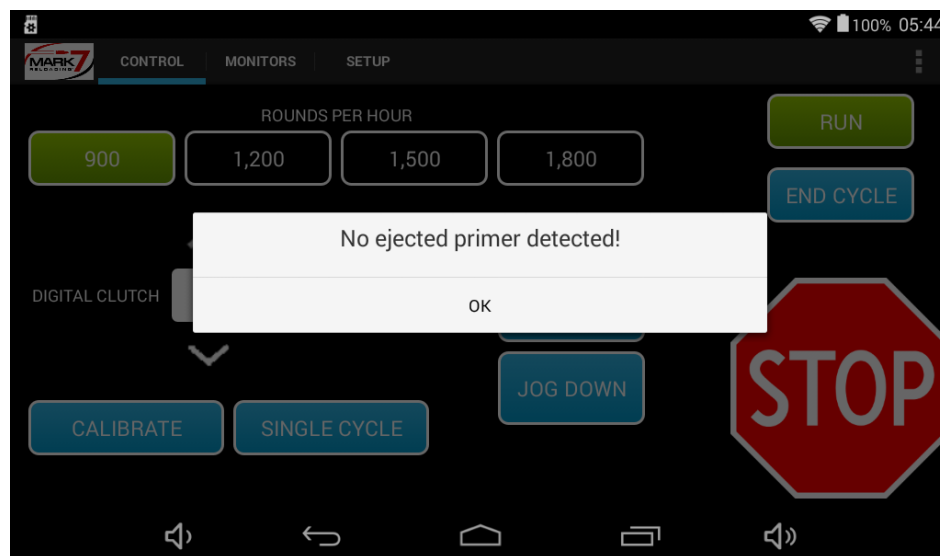

Figure 26: No ejected Primer Notification (1050 X control screen shown)

1. Check the sensors tab on the tablet to ensure that it is enabled (green). If you wish to disable the sensor for any reason it can be done on the fly.
2. During operation the optical sensor may become dirty and require cleaning. The following notification box MAY appear when cleaning is required. In either case the recommended cleaning interval is every 500-700 rounds that are decapped. Using a duster can or compressed



air spray into the port on the front of the Mark 7® DecapSense™ shown below and resume normal operation.

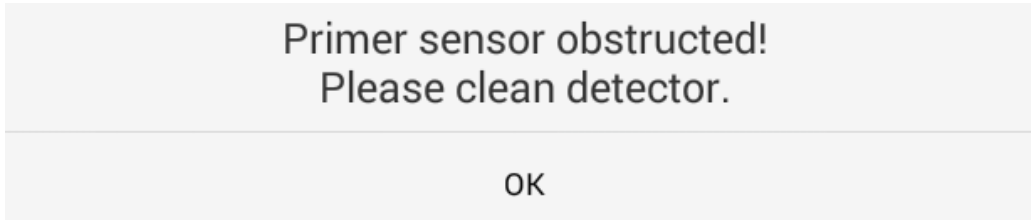

Figure 27: Sensor Obstructed Cleaning required Message

3. To clean the sensor use compressed air to blow into the port on the front of the sensor as shown in figure 27. **DO NOT USE SOLVENTS OF ANY KIND TO CLEAN THE SENSOR.** To clean the SUPER sensor use a cotton swab dabbed with rubbing alcohol to clean around the glass eye inside the housing.

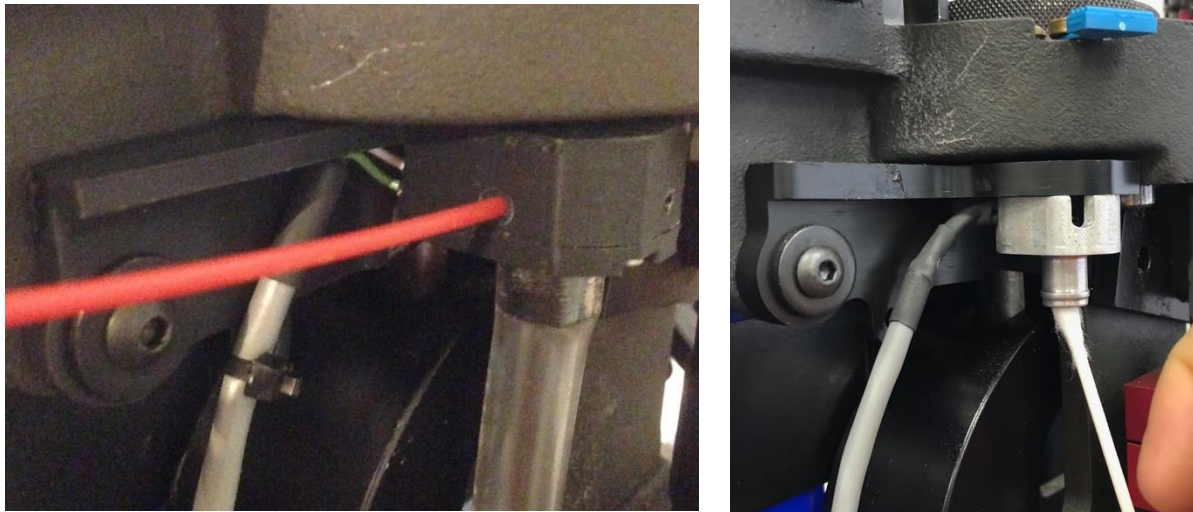

Figure 28: RL Cleaning (left )Sensor & SUPER Cleaning procedure (right)



**WARNING** – cleaning intervals of the Mark 7® DecapSense™ will vary dramatically based upon many factors. WE SUGGEST CLEANING THE MARK 7® DecapSense™ AS OFTEN AS PRACTICAL – IT IS UP-TO YOU TO ENSURE THE SENSOR IS CLEAN.

This is a product that is designed to improve the safety of the reloading operation. NEVER RELY ON THE DecapSense™ SENSOR. You must monitor its use – ALWAYS. Always be close to your machine and available to stop the machine if it needs to be stopped

## SWAGESense® Installation Instructions



Figure 29: Mark 7® SwageSense®

The Mark 7® SwageSense® package includes:

- Mark 7® SwageSense®
- Small Primer Swage Rod
- Large Primer Swage Rod
- Cable Management anchors and zip ties
- .05" Allen Key





The Mark 7® SwageSense® comes pre-installed with the smaller primer swage rod. If you are installing on a 1050 setup with large primers replace the upper swage rod before installing on the 1050.

## Installation Instructions

1. First make sure you have software and firmware listed below (or newer) before installing SwageSense®

**1050-X: SW: 00.00.09 FW 16**

**1050 PRO: SW: 00.00.02 FW 8**

**1050 LTE: ALL VERSIONS COMPATIBLE**

2. Remove the Dillon or current swage rod system you have installed on your 1050. Remove the rod end and thread it into the lower rod on the swage sensor as shown below. The adjustment of the Rod end is not critical to the swage adjustment, thread it in about 3/4 of the way and lock it with the jam nut.



Figure 30: Rod end installed

3. Next install SwageSense® onto the 1050 as shown in the next figure.

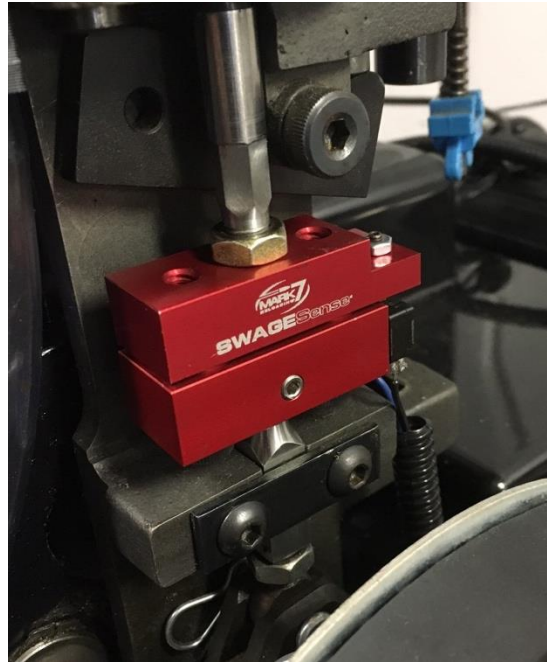

Figure 31: SwageSense® Installed

4. Using the wire management strain relief the cable assembly to the 1050 frame or to the side of the console. Make sure you leave enough play in the wires for the swage assembly to move up and down during machine operation, see below.

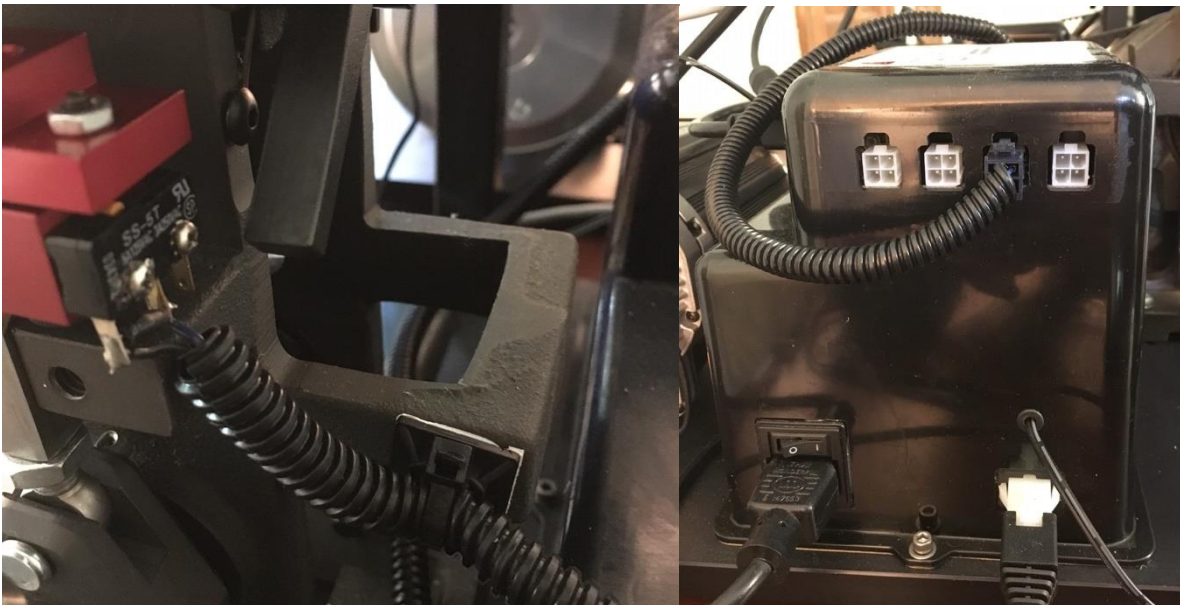

Figure 32: Cable assembly with strain relief, Port to plug into console.



## Adjusting SwageSense®

1. Back off the Swage back-up expander die and swage rod off a few threads and insert a deccaped case into station 3. Move the press head to the bottom position. Adjust the swage back-up expander so it bottoms out against the bottom of the case and lock down the die. Next using 5/16 wrench thread the swage rod up until it bottoms out into the case pocket. Then turn it a  $\frac{1}{4}$  turn more and lock down the jam nut. See the figure below.

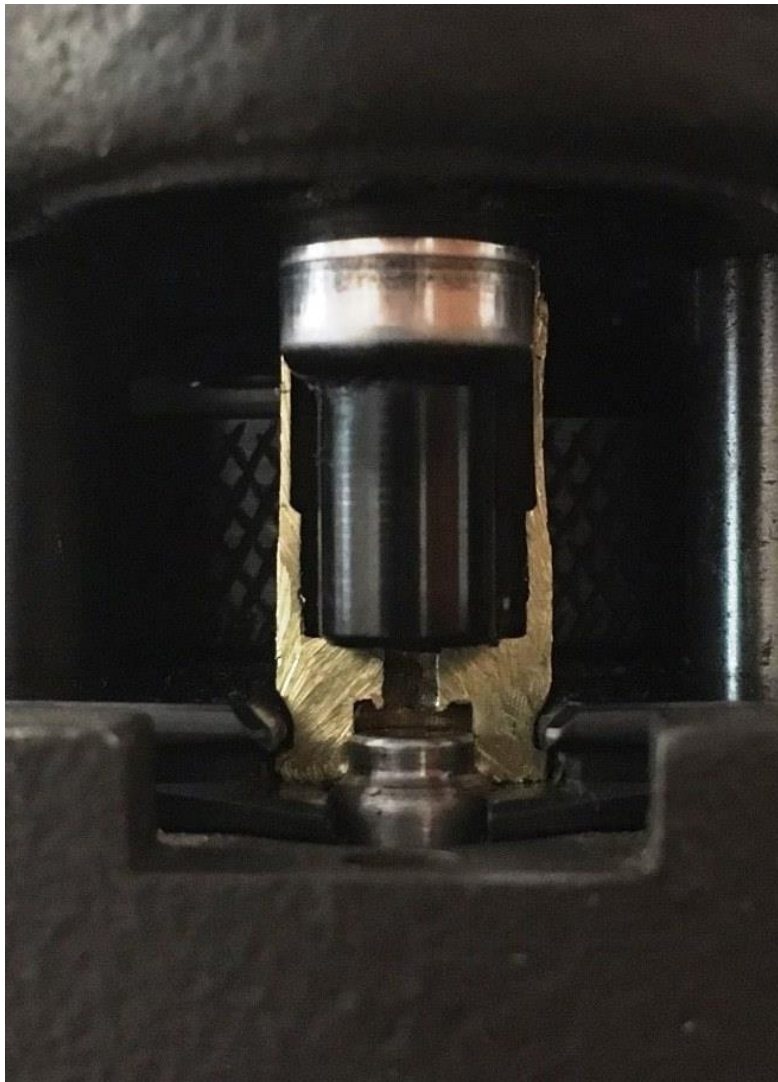

Figure 33: Cross-section of properly adjusted Swage Rod

- The microswitch is pre-adjusted so it will be triggered immediately when the SwageSense® assembly starts to close. If you want to change the engagement of the switch use a .05" allen key and a ¼" open end wrench. We do not recommend adjusting the setting unless it becomes out of adjustment. To adjust tighten the setscrew until you hear the switch trigger, then back it off a ¼ turn and lock down with the jam nut.

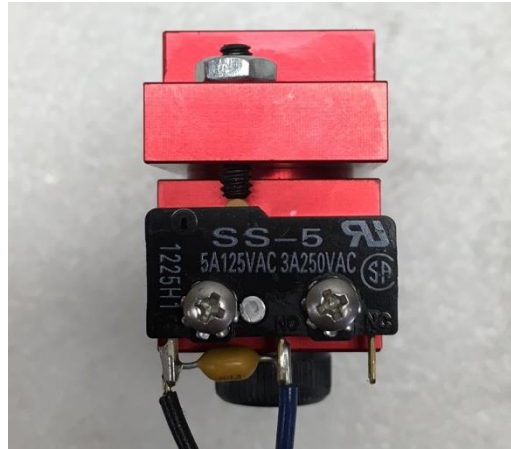

Figure 34: Micro switch Adjustment

- When the SwageSense® switch is triggered the following notification will appear on the reloader application.

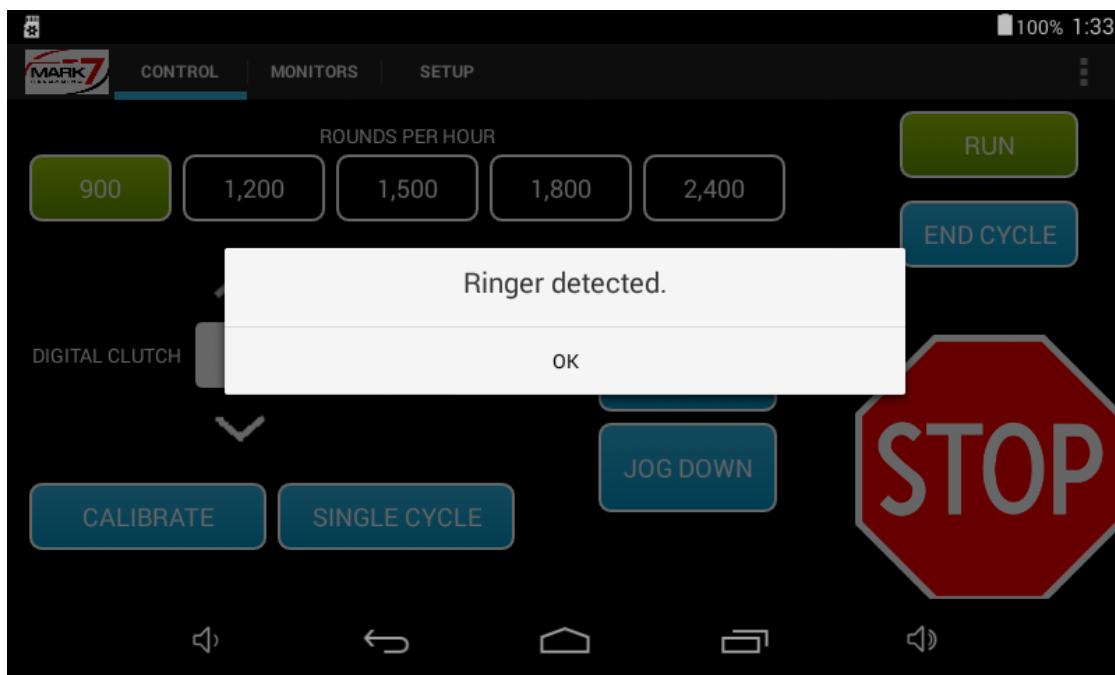

Figure 35: SwageSense® Notification (1050 PRO Control screen shown)



# BULLETSense® Installation Instructions

## Box Contents and General Setup:

1. First review the box contents to make sure all parts are included:
  - a. Setup insert
  - b. BulletSense® Main Assembly
  - c. Mirror and 3/8 socket cap screw and 2.5" long aluminum spacer
  - d. Station 8 Mount and shoulder bolt



Figure 36: BulletSense® Box Contents

2. Check the software and firmware version installed on your machine and make sure it's at least the version listed below (or newer) before installing BulletSense®. The latest updates are available on the software updates page.

**1050 LTE: SW 00.01.12 FW 5**

**1050-X: SW: 00.01.12 FW 32**

**1050 PRO: SW: 00.01.12 FW 27**

3. The Mirror Mount is shipped with a protective film over the surface, before starting setup, peel off the film. If required the Mirror surface should be cleaned with water or isopropyl alcohol, do not use any other types of solvents.





Figure 37: Removing Protective film off mirror surface

**Installing BulltetSense® Main Assembly:**

1. First remove the bin support 3/8" pan head socket cap screw using a 7/32" Allen key

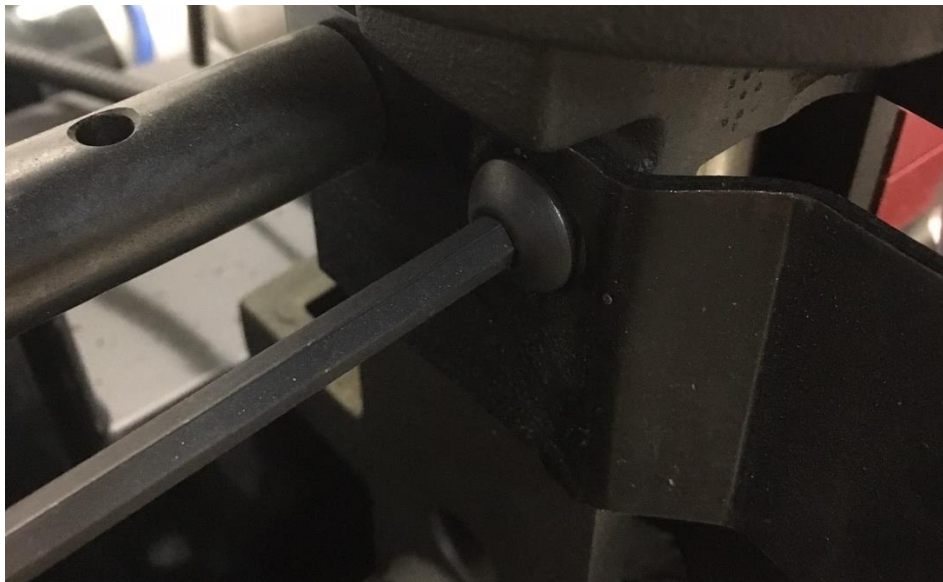

Figure 38: Removing Bin Support Screw.



2. Mount the BulletSense® Main Assembly on the case feeder support pole using the supplied 3/8" Socket cap screw and the aluminum space install the orientation shown below.

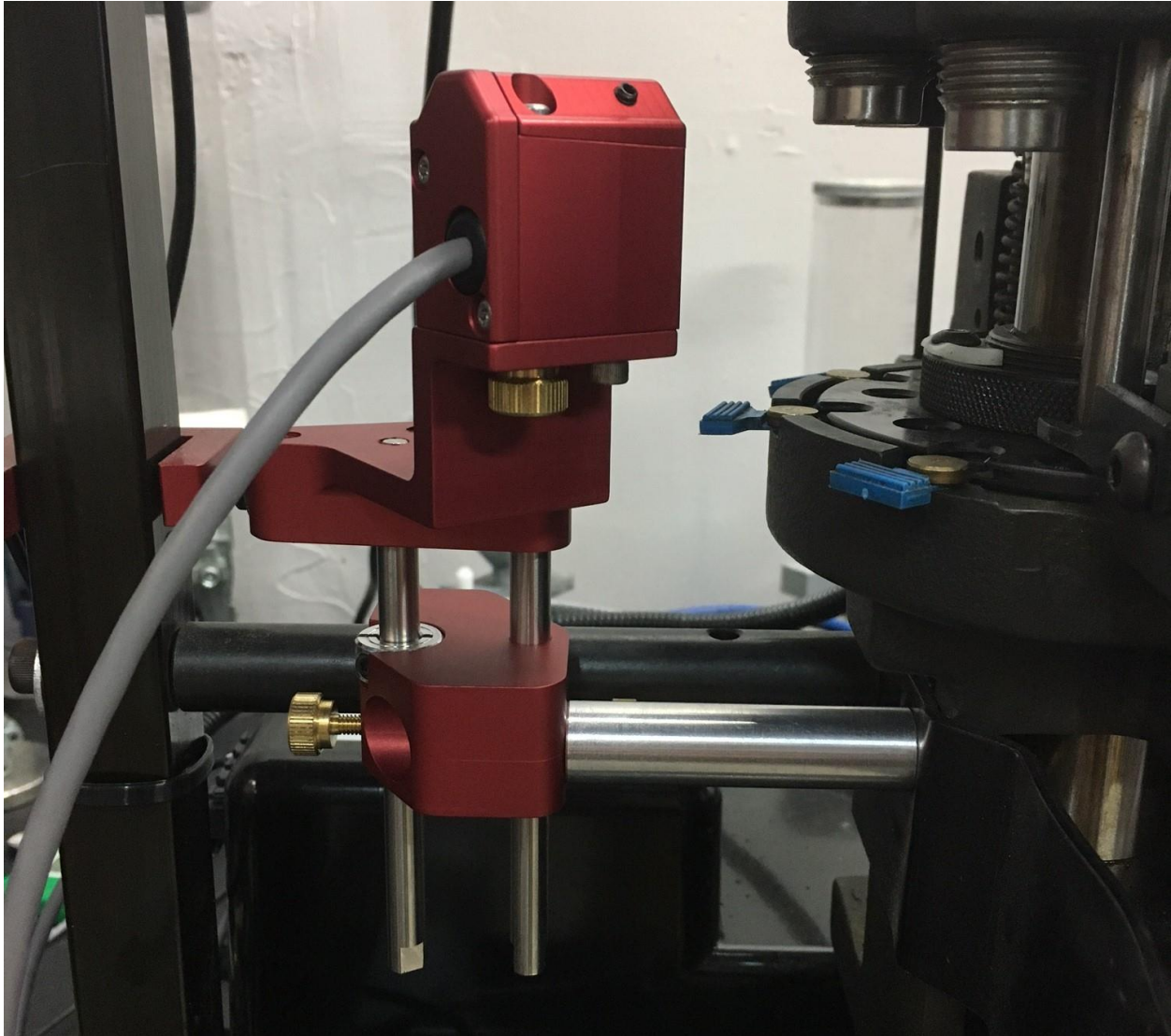

Figure 39: Mounting the Main Assembly

#### Mounting Configurations:

1. Before going any further it is important to decide which station to configure BulletSense®. BulletSense® comes configured to sense bullets in Station 8 from the factory, but it can be configured for either station #7 or station #8. If you are running a Dillon powder check or a Mark 7 PowderSense® you must configure the mount for station #8. If you are not running a powder check configure the mount for station # 7.

2. To switch the mounting configuration loosen the 2X brass thumb screws in the lower mount and remove the upper mount. Loosen the shaft locking collar and re-clamp on the rod with a slight gap from the upper mount as shown below.

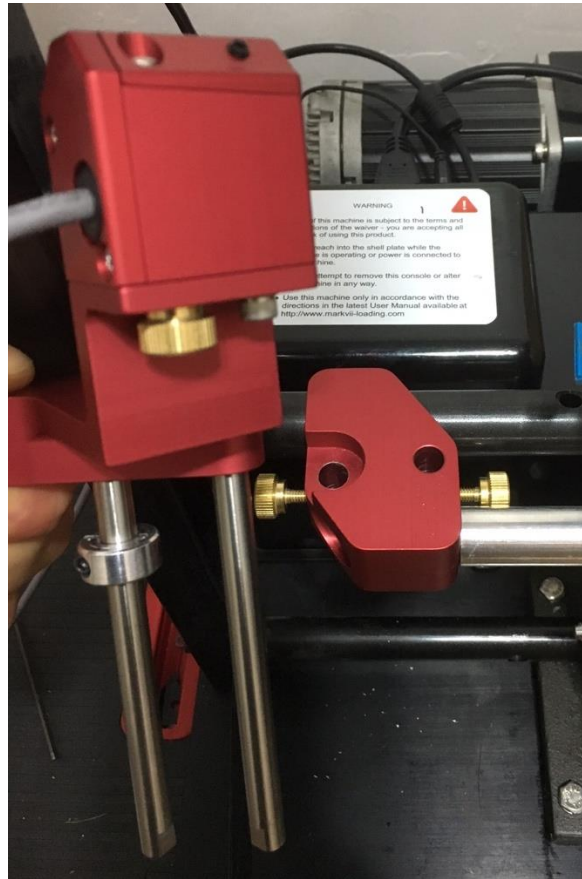

Figure 40: Removing the upper mount for station configuration change

3. Remove the 2X 5/16" threaded dowel pins from the upper mount. Use a 1/4" wrench to remove the pins from the lower mount and thread them into the desired mounting configuration shown in the next figures.



Figure 41: Removing the 5/16" dowel pins



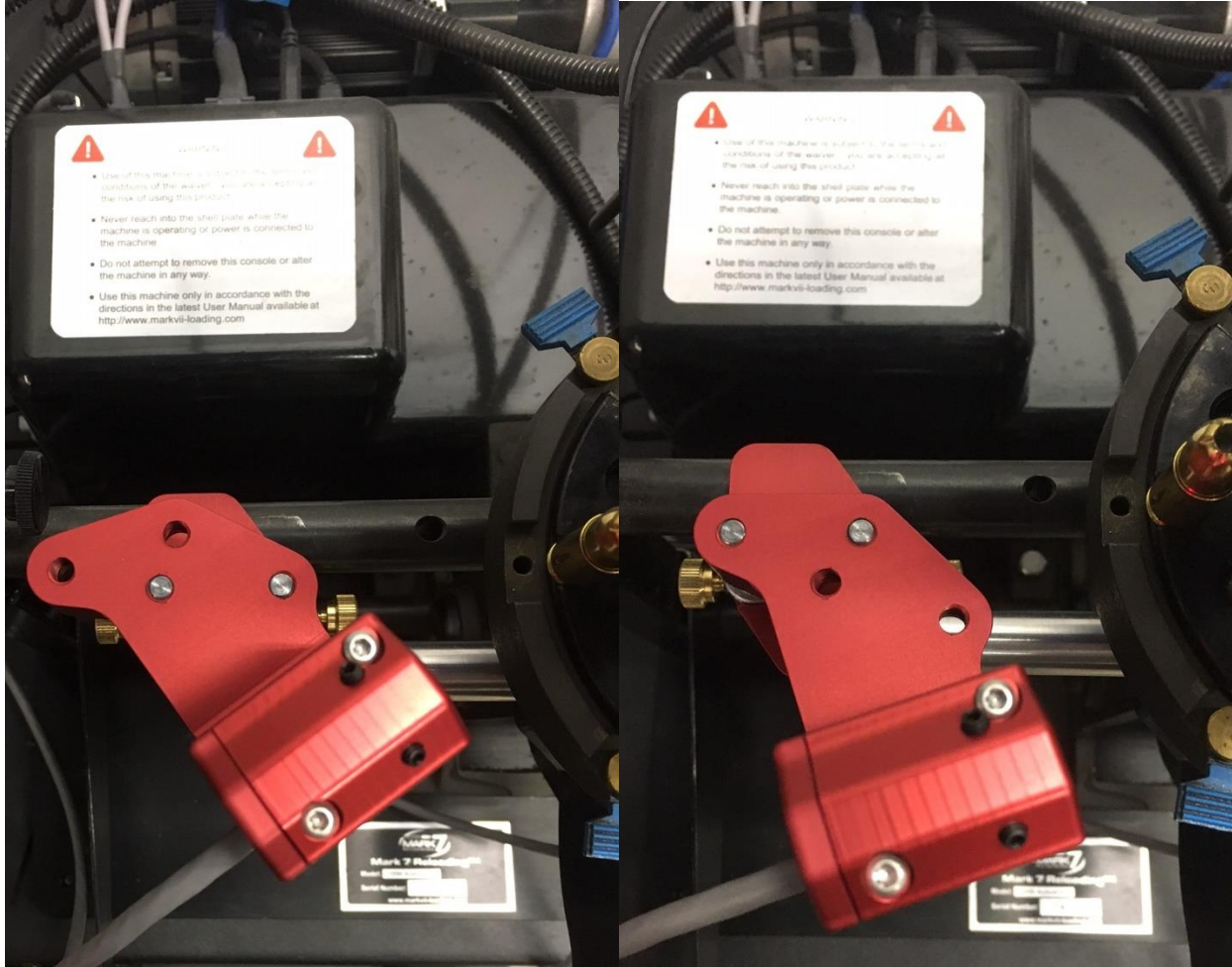

Figure 42: Station 7 (Left) Station 8 (Right)

### Station 7 Setup and laser Alignment:

1. If you wish to mount BulletSense® to sense at station 7 the configuration as shown on the left in the above image. In this configuration the Mirror is installed on the primer tube.
2. Connect BulletSense® to I/O Port #3. Do not power on the console at this point.
3. Remove the Dillon low primer sensor/ PrimerSense® assembly and the knurled primer tube top nut. Then remove the priming mechanism and slide it off the primer tube. Sometimes a flat screw driver is needed to open up the clamp for easier removal.

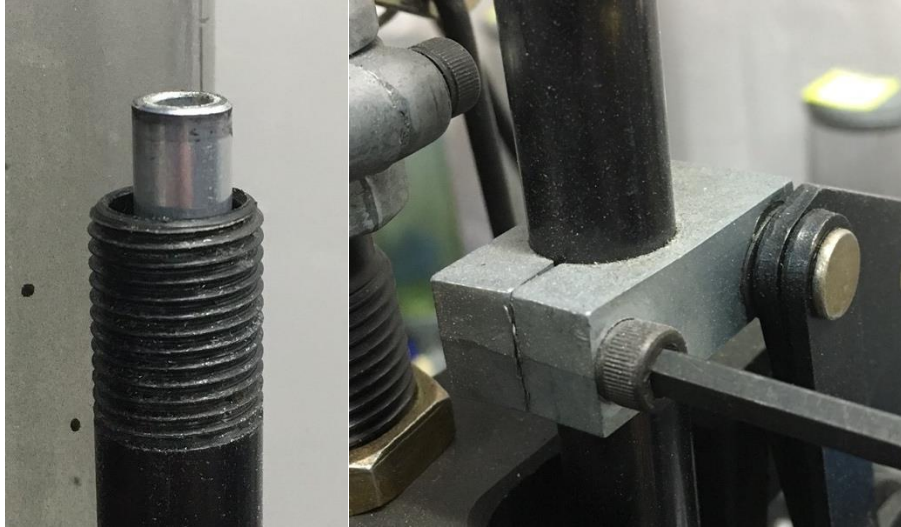

Figure 43: Removing low primer sensor and priming mechanism from priming tube

4. Slide the Mirror down the tube in the orientation shown below. Gently tighten the upper and lower clamps evenly until the mount begins to tighten, but can still be easily rotated by hand. The mirror needs to be aligned with the laser so keep the mount snug but not fully tight at this stage. **NOTE: Due to variations in the Dillon priming tube it may be necessary to wrap a thin section of tape around the tube to achieve a tighter clamp, do not over tighten the screws.**

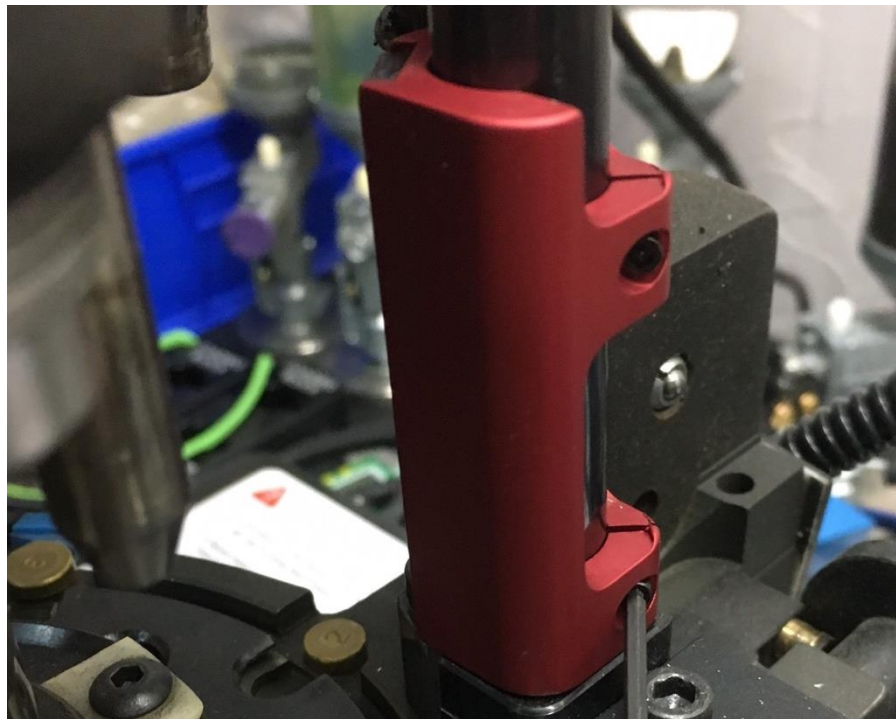

Figure 44: Mounting the mirror for Station 7



5. Power on the console which will automatically turn on the laser. Next step is to align the laser so the mirror reflects the laser beam into the sensor. When you first power on the sensor look at the mirror to see where the laser beam is directed. Use a white card to help find the exact position if it's difficult to detect the position.



**WARNING** – Class 3R laser: avoid eye contact at all times; do not look directly into the laser when adjusting the laser alignment.

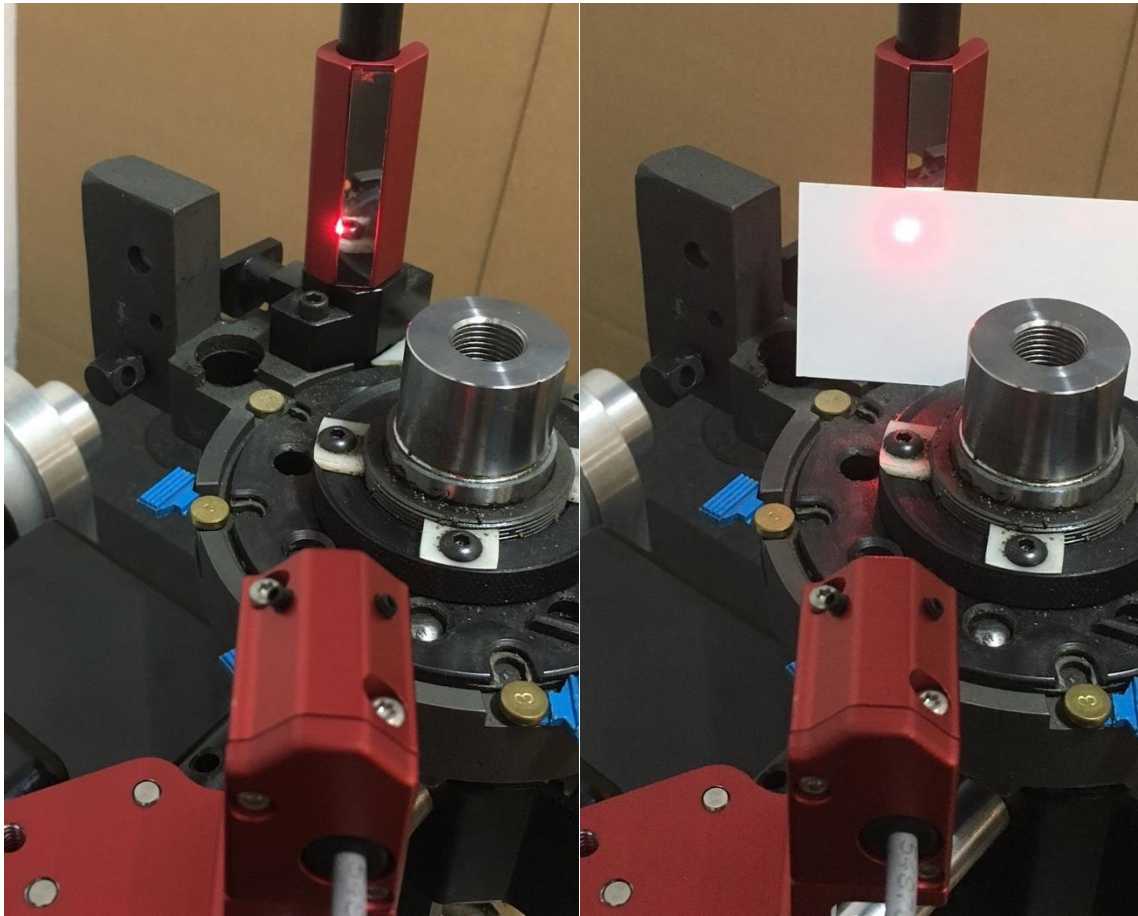

Figure 45: Laser Beam (Not aligned) directed on the edge of the mirror.

6. Adjust Laser beam onto the mirror with the 2X 6-32 set screws on the top of the assembly. Once the Laser diode is hitting the mirror surface. Rotate the mirror so the laser beam is reflected back to the sensor main body. Once the reflected laser beam appears on the sensor main body, continue adjusting the set screws to direct the laser beam into the sensor hole as shown in the following figures.



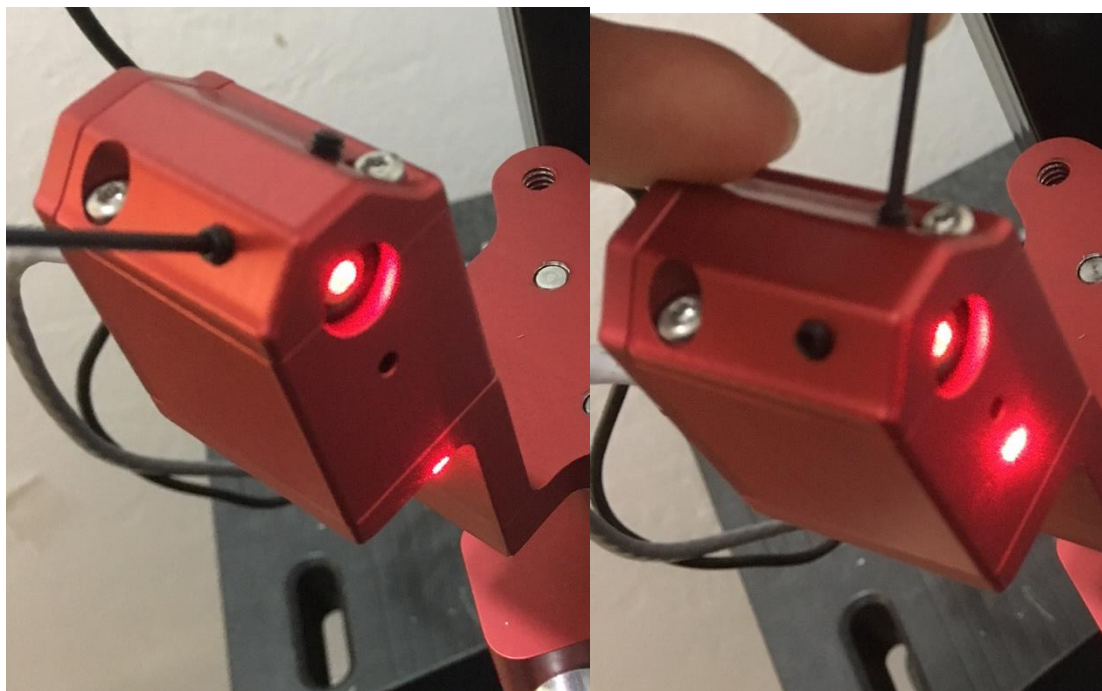

Figure 46: Adjust the set screw to align the laser. Before adjustment (Left) Mid Adjustment (Right)



Figure 47: After Adjustment



7. Now that the laser beam is aligned lock the mirror in-place by gently tightening the 2X socket cap screws in the Mirror Mount. **Do not over tighten.**
8. Next the Sensor vertical height must set for the given caliber and projectile being used.
9. To set the height, place a case with the neck flared in Station #7 and place a bullet in the proper orientation into the case at the level where it would be when dropped from the Mr. Bulletfeeder drop tube.
10. Loosen the 2X brass thumb screws and gently position the upper mount so the laser beam goes OVER the tip of the bullet and hits the mirror, the reflected beam should return and hit the tip of the bullet so the beam path is broken as shown below. Put a white card above the bullet and adjust the mount so there is a slight gap between the tip of the bullet and where the beam is positioned as show.

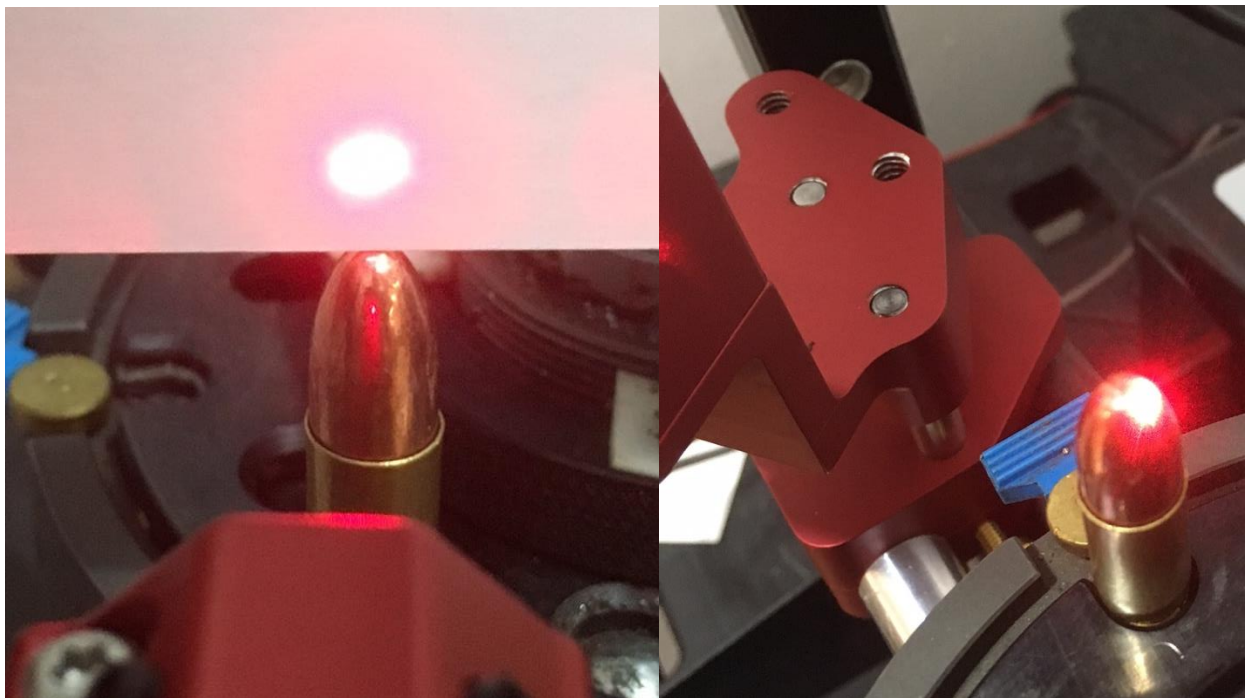

Figure 48: Direct beam over the tip of the bullet (left) the reflected beam will hit the back side of the bullet (Right)

11. When the vertical height is adjusted properly a shadow will be cast on the sensor preventing the sensor to see the laser beam. When the bullet is not present, upside or sideways the beam will pass over the bullet and contact the sensor triggering the machine to stop.



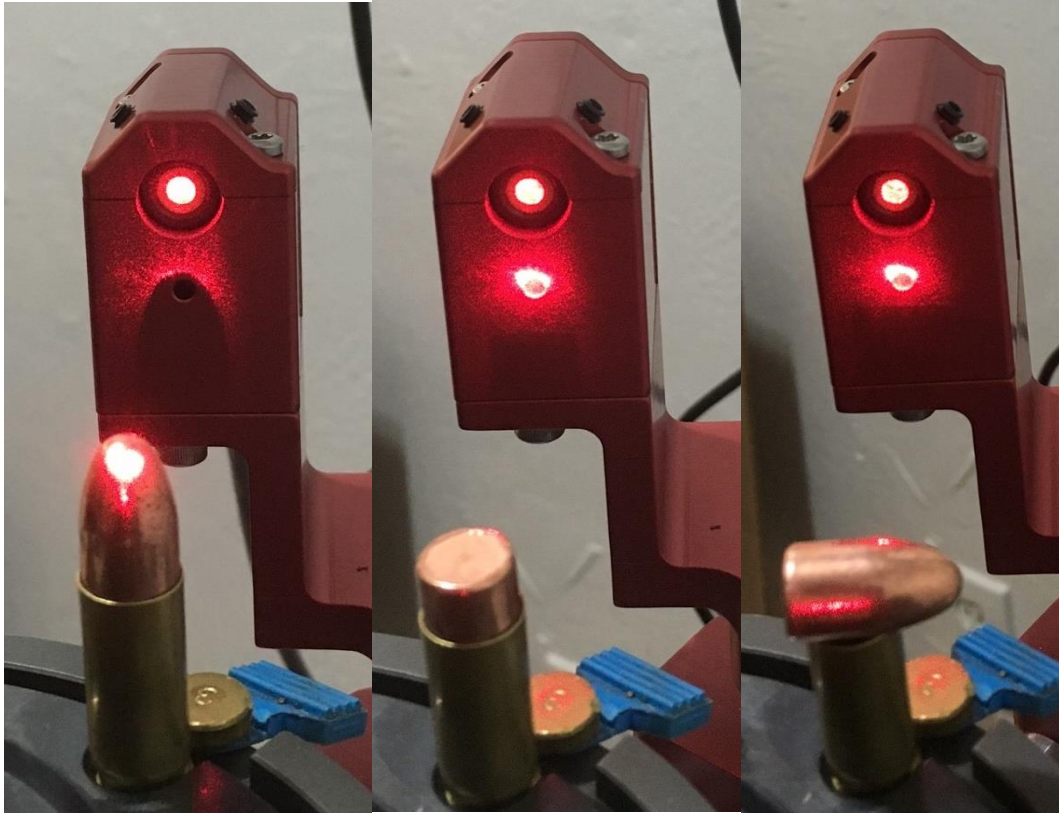

Figure 49: Properly orientated Bullet- Beam interrupted (Left) Improper orientated Bullet – Beam not interrupted (Right)

12. Once the proper height has been achieved tighten the 2X brass set screws and the shaft locking collar. The shaft locking collar is used to lock in the required height adjustment. If you need to remove the BulletSense® assembly for press maintenance or for any reason you can choose to remove the upper mount only. When re-installing, the vertical position will be maintained.

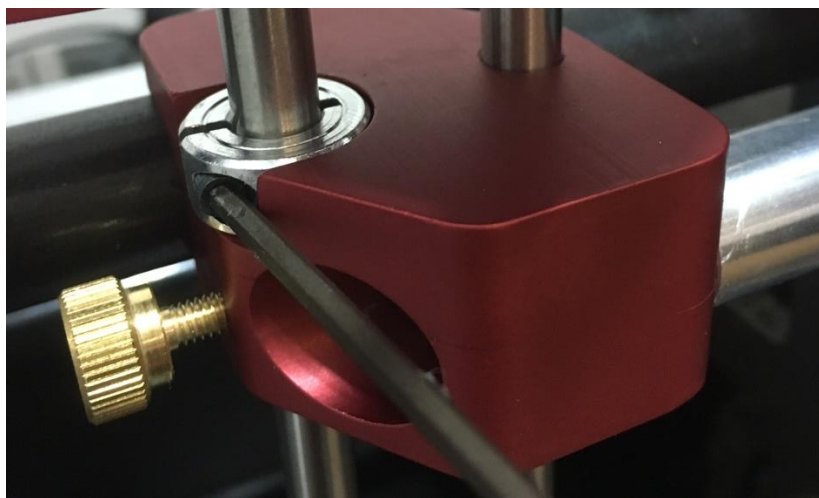

Figure 50: Locking height adjustment in place



**Station 8 Setup and laser Alignment (For use with PowderSense™):**

1. Refer to the mounting configuration section above to make the sensor assembly is configured properly to sense in station 8. In the station 8 configuration the mirror is mounted off a remote mount to the right of station #3.
2. Hold the primer rocking assembly in place with your finger or a pry bar and remove the shoulder bolt. Place the split washer on the longer shoulder bolt supplied with the Station 8 hardware and fasten the mount to the 1050 frame.

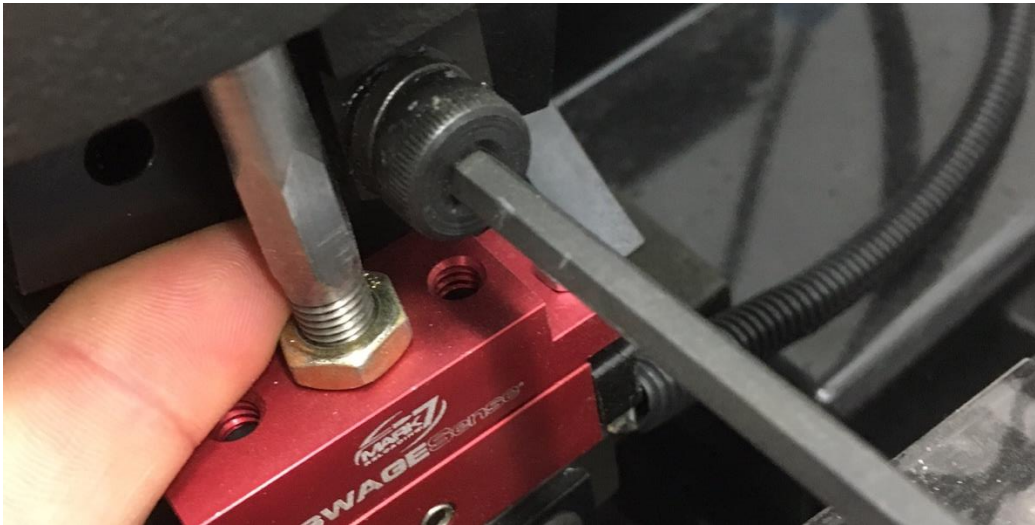

Figure 51: Removing the shoulder bolt to mount on station 8 adapter.

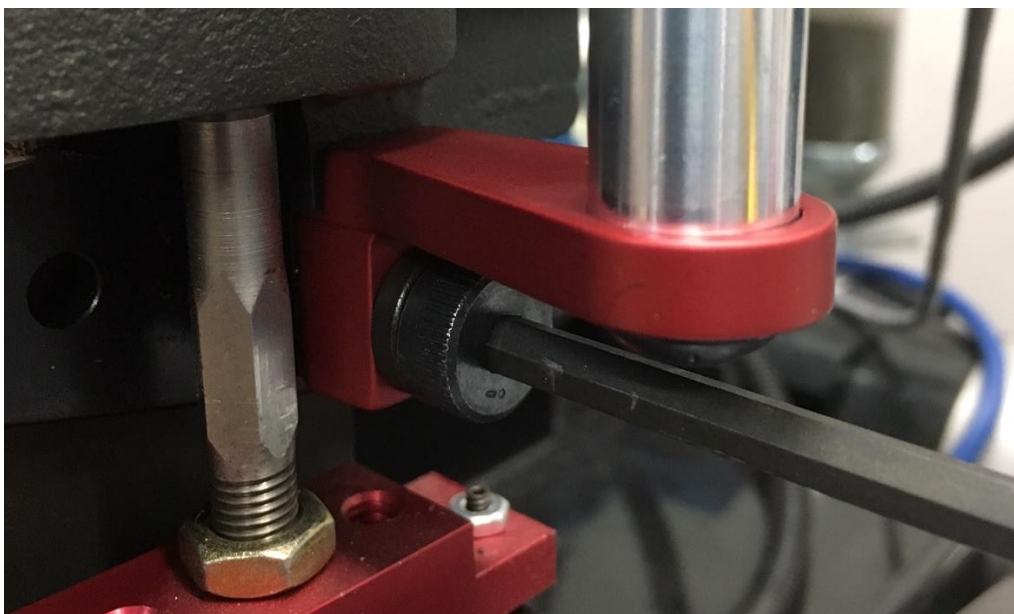

Figure 52: Mounting station 8 adapter to the 1050 frame.

3. Slide the mirror onto the rod in the orientation shown. Gently tighten the upper and lower clamps evenly until the mount begins to tighten, but can still be easily rotated by hand. The mirror needs to be aligned with the diode so keep the mount snug but not fully tight at this stage.

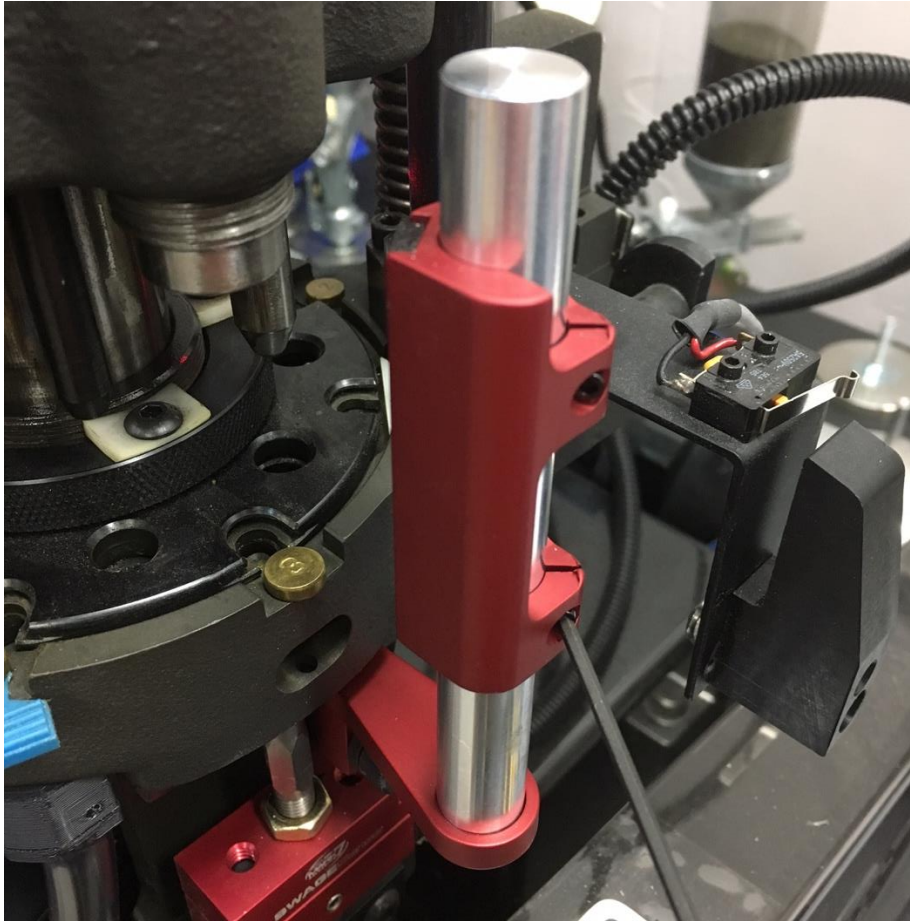

Figure 53: Mirror Mounted to Station 8 adapter rod.

4. Use the same method of aligning the laser as described in the station 7 setup.
  - Point the Laser onto the Mirror (use set screws and slight rotation of head if needed)
  - Rotate the Mirror so the reflection is back onto the sensor body
  - Further adjust the set screws so the laser reflection enters the sensor hole.
  - Adjust the height of the Upper Mount so the laser beam goes over the projectile and then hits the tip of the back side of the bullet.
  - Lock Upper Mount and Mirror Mount in position.



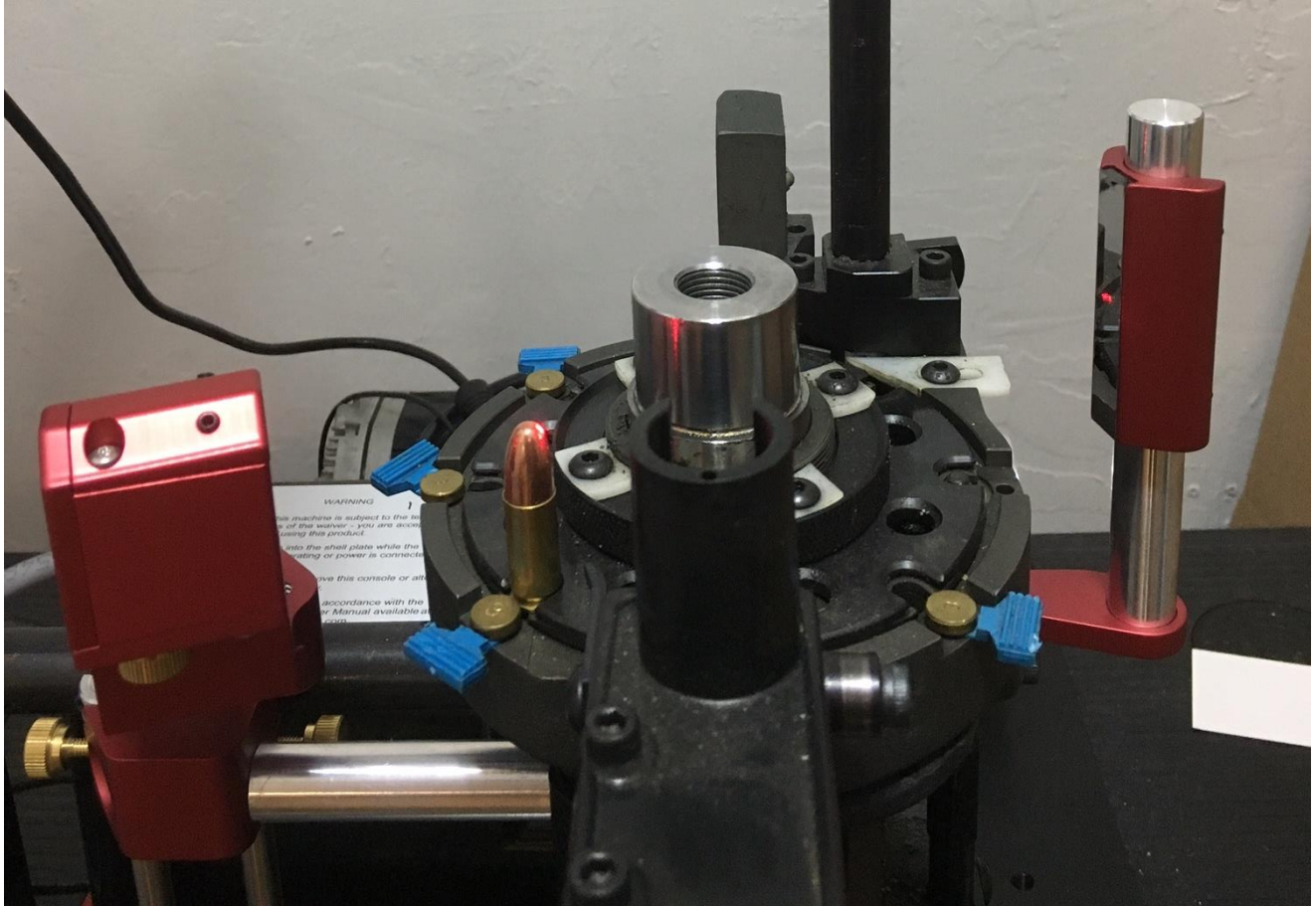

Figure 54: Station 8 Setup (tool head removed for picture)

### Operating BulletSense®:

1. With a clear shell plate enter the Reloader application, confirm that you have the required software firmware version or newer as outlined in the first page of this document.
2. BulletSense® Plugged into I/O Port 3.
3. Confirm that the laser is aligned with the sensor opening.
4. Perform a system calibration the go to the sensors tab and make sure BulletSense® is enabled.
5. Press RUN or Single Cycle. With a clear shell plate the following notification should appear stating that a “Bullet Not Properly Positioned.”

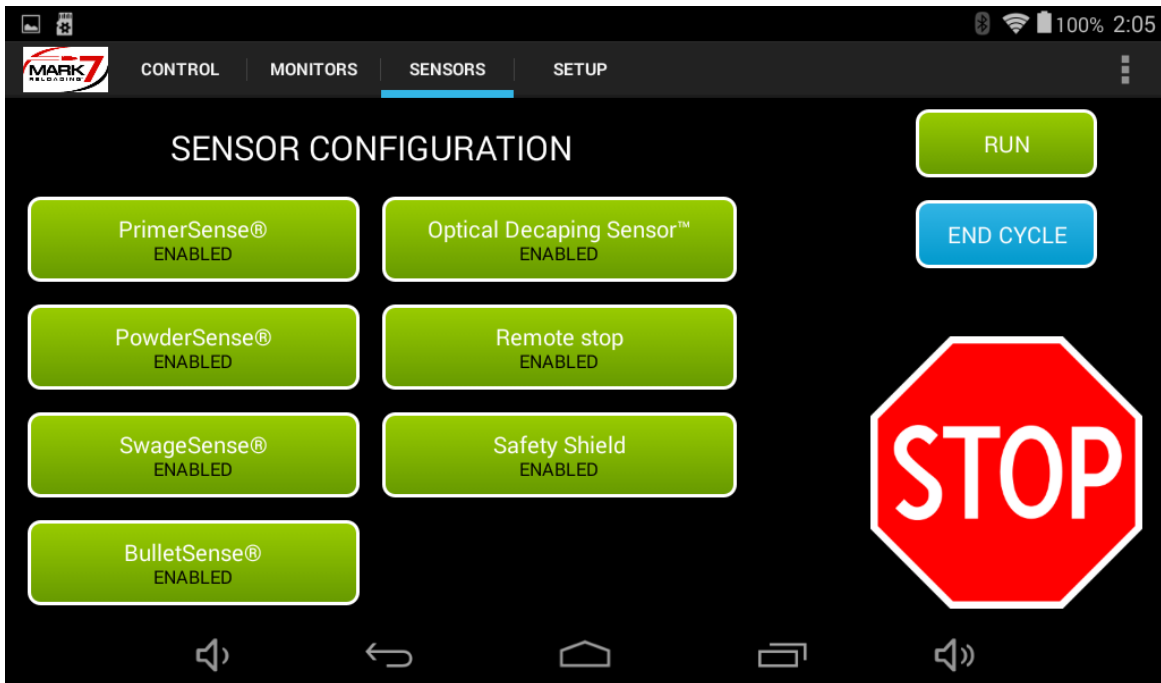

Figure 55: Sensor Page (enable BulletSense®)

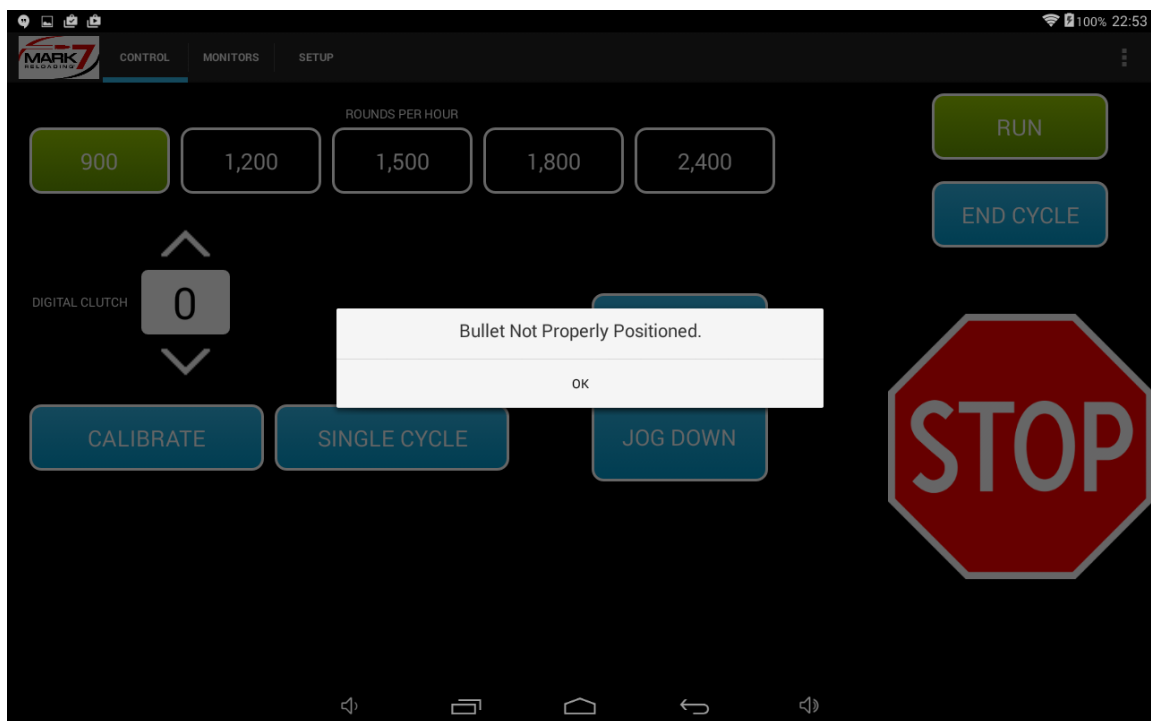

Figure 56: BulletSense® Notification





## POWDERSense®

### \*With Dillon Powder Check sensor Installation Instructions

PowderSense® comes either pre-wired as a complete kit or as a cable assembly that you wire into your existing Dillon powder check sensor. Wiring instructions are included with the wiring kit. Powder check Installation instructions are included with the powder check sensor. Plug the PowderSense into Port #7. Please refer to the console input section for more detailed information

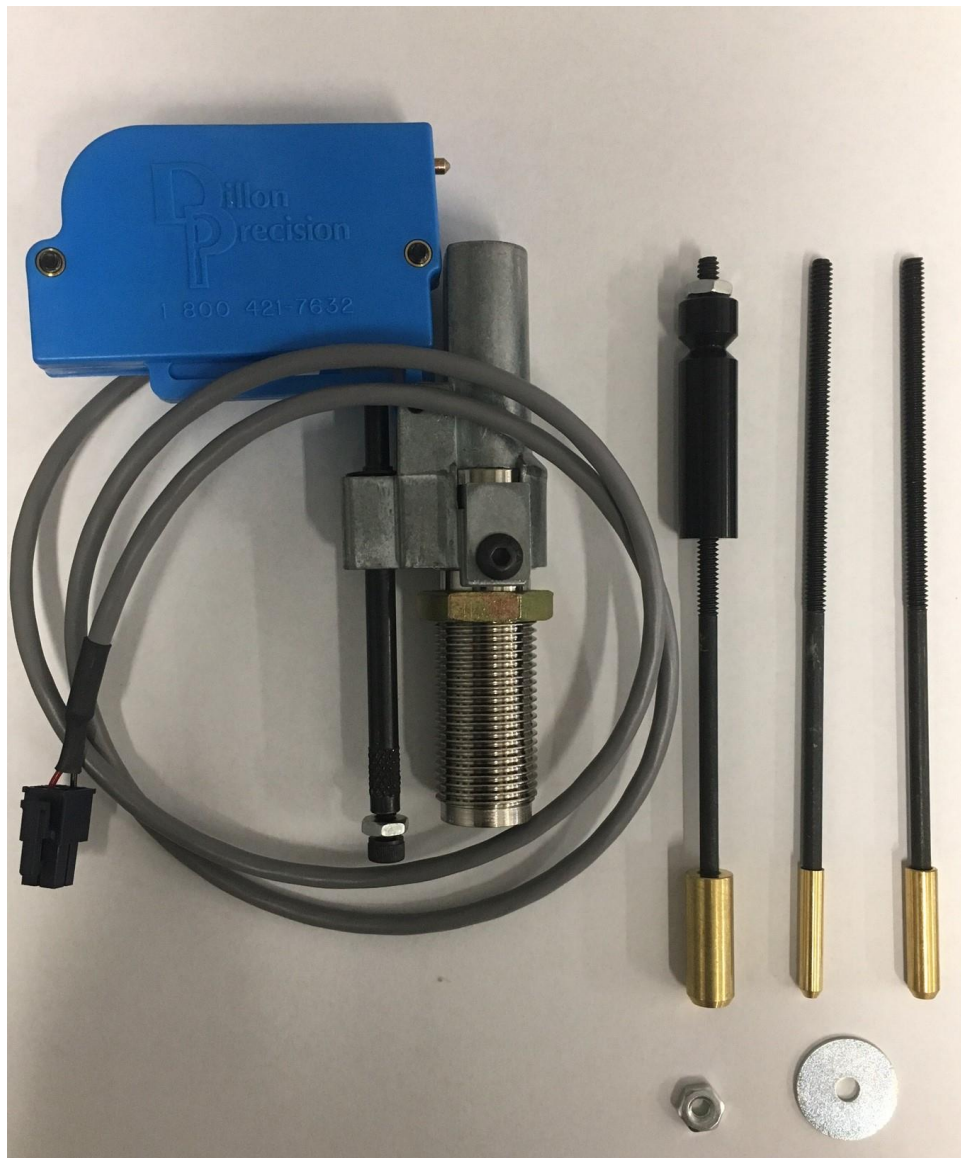

Figure 57: PowderSense® Complete Kit

The powder check sensor installs in station #6 on the Dillon 1050. If you are using a Mr. Bulletfeeder remove the seating die at station# 7 and move the bullet drop tube into Station #7. Then remove the standard seating die and install a Seating/Crimp combo die in station #8. For GSI bullet feeders you run the powder check along with separate seating and crimp dies.



Figure 58: PowderSense® with Mr. Bulletfeeder and Redding seat/crimp combo die



## Mark 7®1050 Shield Installation and Setup

Install the shield hinges to the 1050 Pole as shown below. Once the shield is installed they can be adjusted to the proper level.

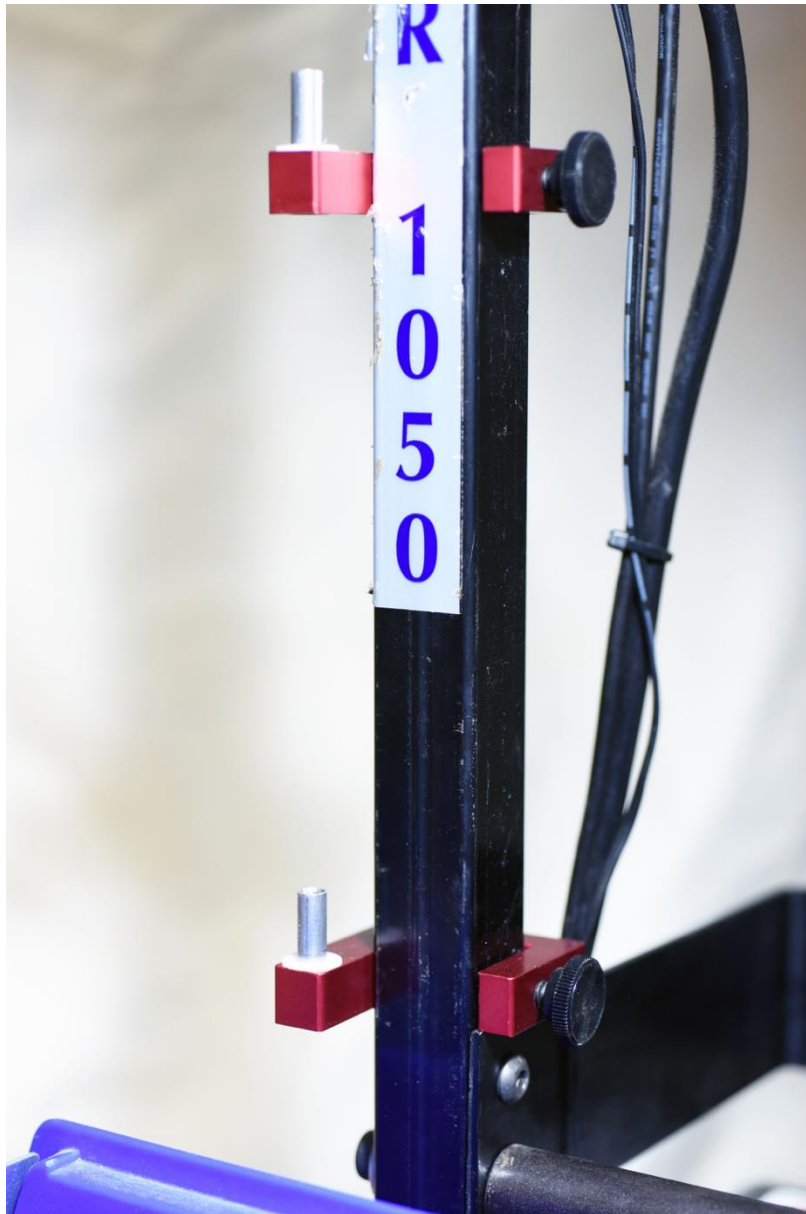

Figure 59: Shield Hinges on 1050 post

Remove the outer screw on the primer tube base and install the latch bracket as shown below.

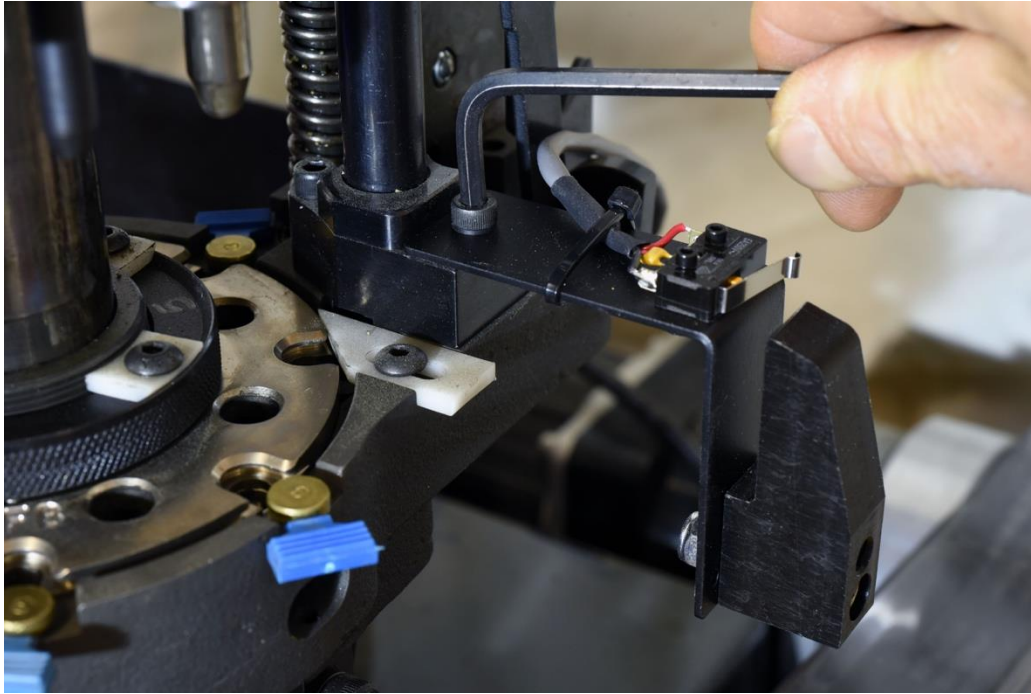

Figure 60: Installing the Shield Latch

Rotate the latch knob CC (towards the front of the machine) and place the shield on the hinges. Close the shield then adjust the hinges so the bottom of the shield rests just above flat on the knob.

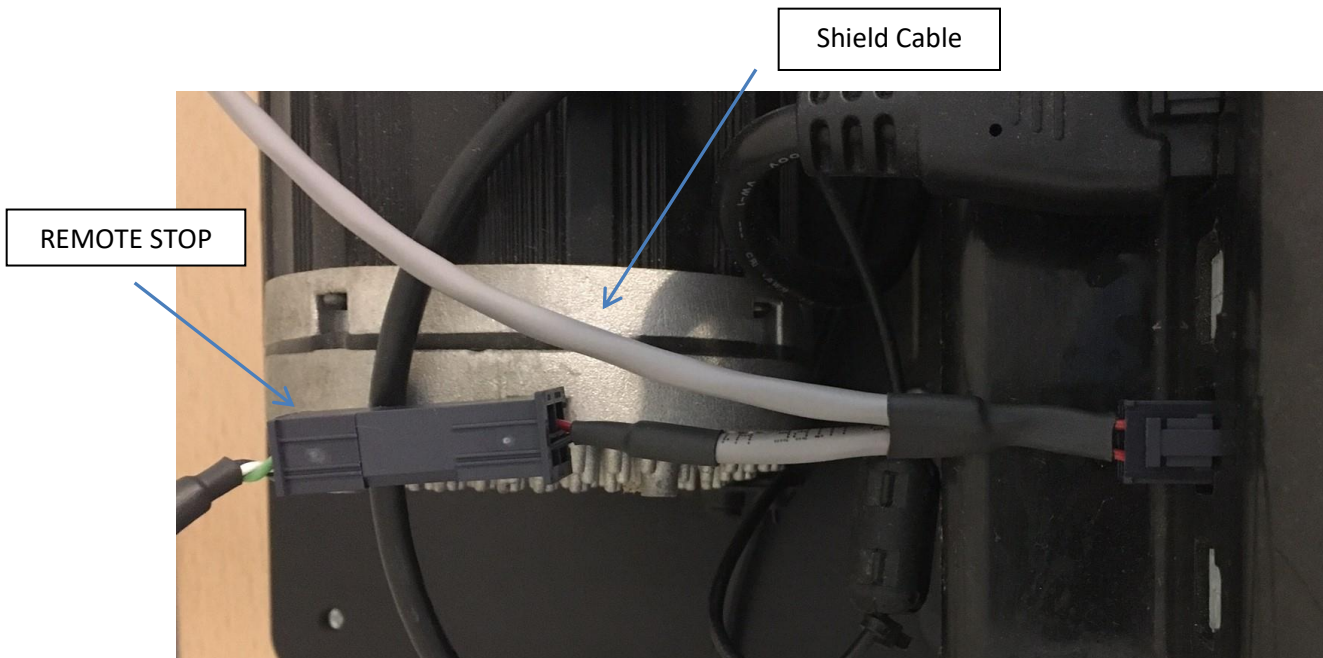

Figure 61: Cable Assembly





Plug the shield into port # 6 which is the same port as the remote stop. If you have a remote stop plug it into the female connector pig tailed to the shield cable assembly.

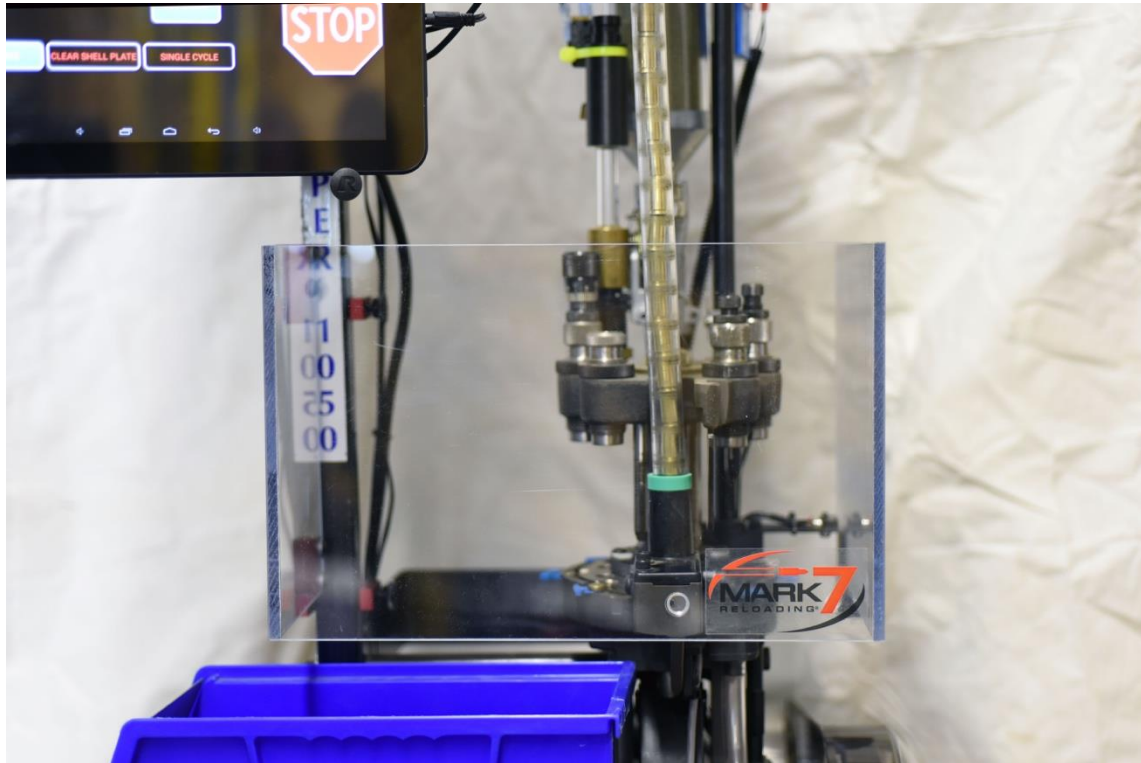

Figure 62: 1050 Shield Installed

When the shield is open the following notification will appear on the tablet. The software firmware release version 01.02 (9/27/16) or newer is required. The RUN, END CYCLE and SINGLE CYCLE commands are disabled with the shield is open. The JOG functions are not disabled and the tool head can repositioned using those commands or by press STOP twice and manually actuating the large sprocket with a 5/8" wrench.

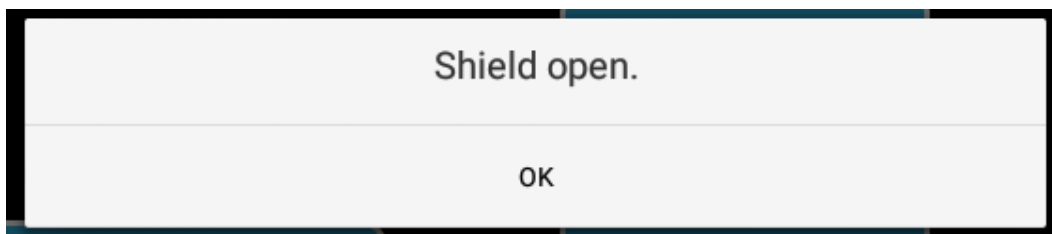

Figure 63: Shield Open Notification



## Operating Instructions:



**WARNING** - This equipment uses a high power motor and drive belt system. Avoid contact with any part of the drive belt or sprockets. Contact with the drive belt or sprockets could result in serious injury or death.

### Main Screen



Figure 64: System Home Screen

When the tablet is powered on the main screen shown above will launch. This screen contains the Reloader, firmware and software applications. Before selecting the Reloader application, make sure the console is powered on, all system cables are connected and the shell plate is clear.



## Waiver Screen & Software and Firmware version

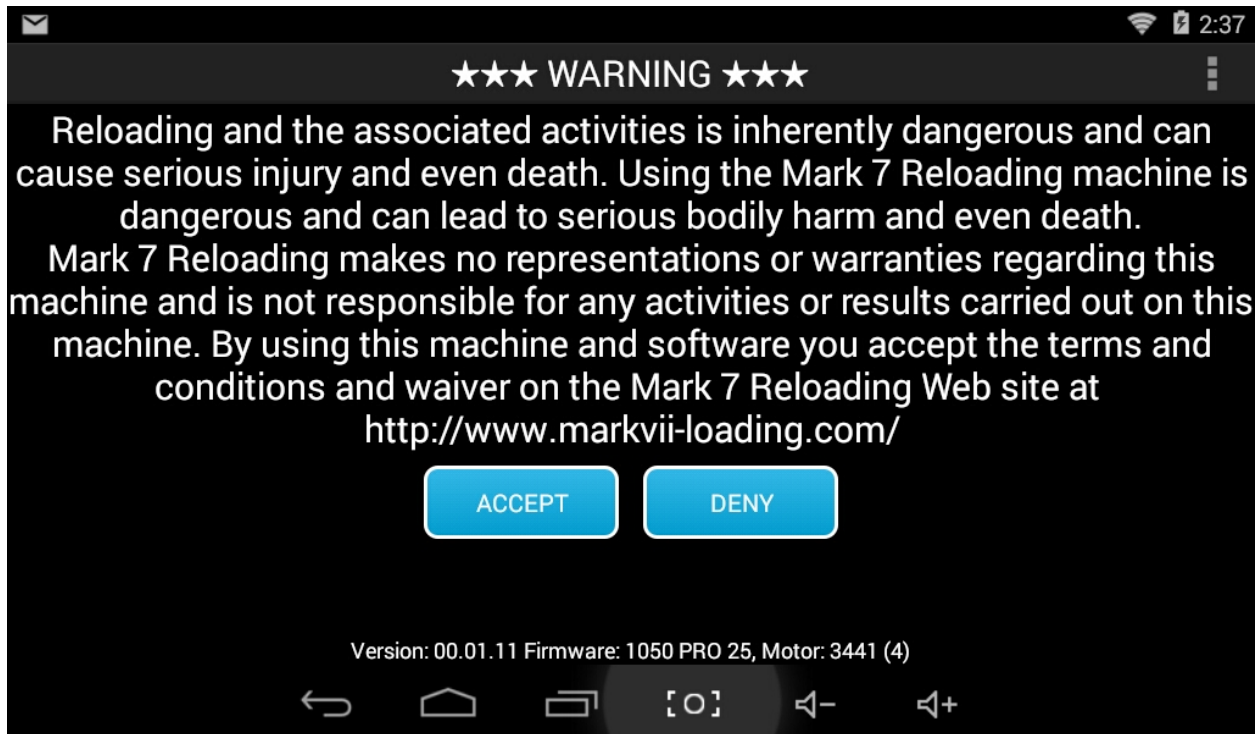

Figure 65: System Waiver Screen (1050 PRO SHOWN)

Following proper installation of the Mark 7<sup>®</sup> Autodrive the user will be able to power up their tablet and console to launch the Mark 7<sup>®</sup> Autodrive application. The image above is the first screen the operator will see. The operator must accept the terms and conditions and waiver on the Mark 7<sup>®</sup> Reloading website. If the operator accepts these terms the operator can touch ACCEPT on the screen. If the operator does not accept these terms they must touch DENY which will immediately close the application.

The software and firmware version will be displayed at the bottom of the waiver screen as shown above.

### Before each session of use of the machine

Before each loading session, fully inspect the machine – this will reduce the errors you may encounter. Some of the items to inspect (for exhaustive list please refer to the Dillon Precision manual) include:

- Ensure the index arm is tightly seated against the machine and the shoulder screw that attaches it is tight. The spring for the index arm must be properly installed. The index pawl must not be damaged or have a dent in the front where it indexes the plate.
- The index plate must be free of debris.
- Visually inspect all lubrication points. Check the need for lubrication before every session and apply it as necessary at the key lubrication points outlined in the Dillon Precision manual. Insufficient lubrication creates a potentially dangerous situation and may lead to unreliable results as well.

## Control Screen

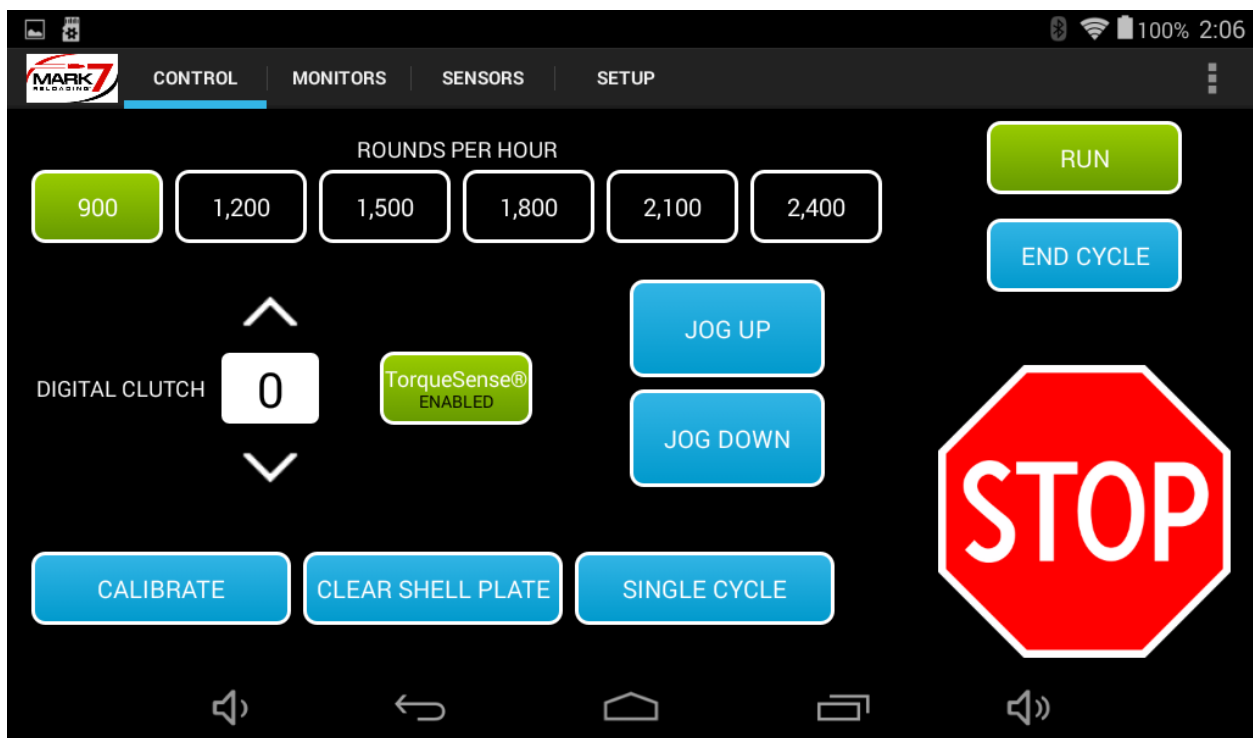

Figure 66: System Control Screen (1050 PRO shown above)

**CALIBRATE** - The function is the first operation that must be run before fully running the Mark 7® Autodrive. CALIBRATE signals the Mark 7® Autodrive to find the top and bottom of the presses stroke. Once calibration is completed all Mark 7® Autodrive features can be used. The shell plate must be clear when calibrating. Calibration takes approximately 10 seconds to complete.

**SPEED (Rounds Per Hour)** – After Calibration is completed you may select the speed in which to operate the machine. These can also be changed on the fly while the press is in motion. The 1050-X has 4 speed options 900, 1200, 1500 and 1800. The 1050 PRO has 2 additional speed options 2100 and 2400.



**DIGITAL CLUTCH** - The Digital Clutch setting is the way in which the operator controls the torque output of the motor. We recommend keeping the digital clutch at the lowest level required to complete a desired action, whether it is re-sizing, or making complete ammunition. When the operator hits the torque limit the Mark 7® Autodrive will stop and notify you. To continue operations increase the digital clutch value and hit RUN until the cycle is completed.

**TORQUESense®** When enabled TorqueSense® varies the motor torque throughout the Stroke, dropping the torque primarily on the upstroke to a minimum baseline level. This increases the machines sensitivity if a jam occurs in the upstroke due to a case feed or shell plate indexing issue. There may be some instances when TorqueSense® will need to be disabled so the motor torque on the upstroke can be increased via the digital clutch, such as if the system torques out half-way through sizing a rifle case. If the TorqueSense torque limit is exceeded the machine will stop and notify you on the tablet. TorqueSense® can be enabled or disabled by pressing the ToqueSense® icon.

**RUN** - The RUN function signals the Mark 7® Autodrive to begin operation at the settings requested.

**ROUNDS PER HOUR** - The 900, 1200, 1500, and 1800 options under ROUNDS PER HOUR give the operator the ability to choose their desired cycle speed.

**CLEAR SHELL PLATE** - The CLEAR SHELL PLATE command will lower the 1050 tool head just enough so the shell plate can be rotated to clear the brass at any point during loading. This command will only work when the press is in the HOME position at the top of the stroke.

**SINGLE CYCLE** - The SINGLE CYCLE function allows the operator to run a single cycle. This command will only work when the press is stopped and in the top position.

**END CYCLE** - The END CYCLE function will complete the current cycle and return to the top position.

**JOG UP** - The JOG UP function will incrementally move the press upwards. The JOG UP functions is useful in clearing jams that may occur. The JOG UP function will only work when the Mark 7® Autodrive is at a stop.

**JOG DOWN** - The JOG DOWN function will incrementally move the press downwards. The JOG DOWN function will only work when the Mark 7® Autodrive is at a stop.

**STOP** - The STOP function will stop the press from moving in any event. Pressing STOP twice will switch the motor into neutral which is helpful if the press needs to be manually actuated.

## Monitors Screen

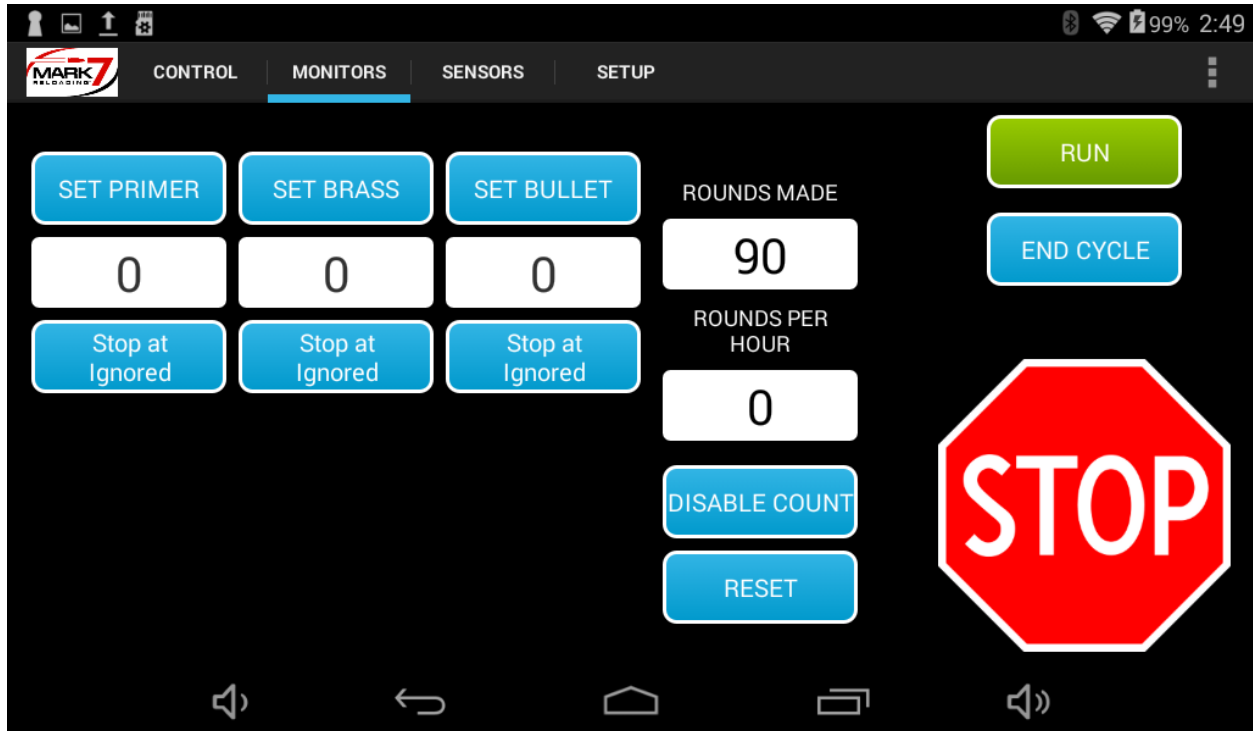

Figure 67: System Monitor Screen (1050 PRO)

**SET PRIMER** - The operator has the ability to set the number of primers used before the Mark 7® Autodrive ends its current run.

**SET BRASS** - The operator has the ability to set the number of brass used before the Mark 7® Autodrive ends its current run.

**SET BULLET** - The operator has the ability to set the number of bullets used before the Mark 7® Autodrive ends its current run.

**DISABLE COUNT** - The DISABLE COUNT function gives the operator the ability to not count the amount of rounds made.

**RESET** - the RESET function allows the user to reset the ROUNDS MADE and ROUNDS PER HOUR fields.

RUN, END CYCLE, and STOP functions have the same functionality on the Monitors Screen as they do on the Control Screen.

The buttons underneath the screen either state – STOP at XX or Stop at Ignored. If the latter, the machine will not stop – the monitor is not in use. If the former, the value that you set is the value that the machine will stop on. If you set primers to 100 and the stop at value of 10, then the machine will stop when it has reached 10 primers left (a value of 90 rounds made).





## Sensors Screen

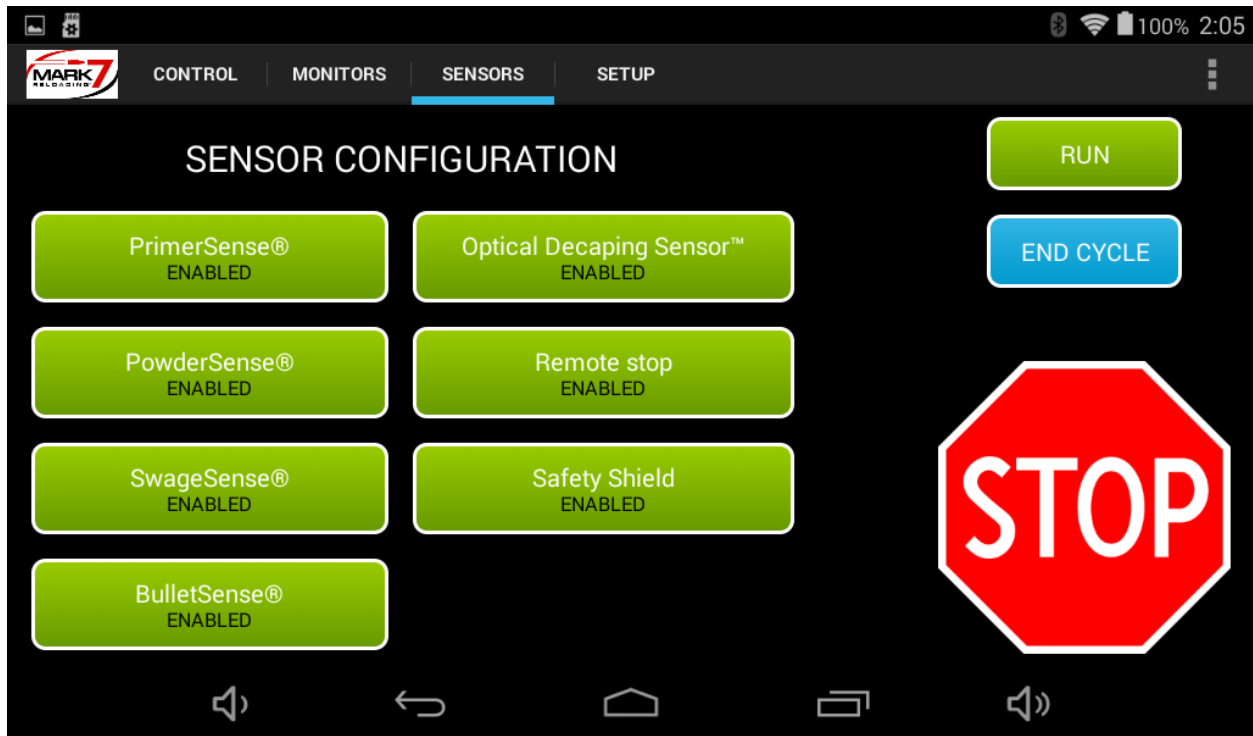

Figure 68: System Sensor screen (1050 PRO)

On the sensors page all optional sensors can be enabled or disabled at any point during machine operation. We recommend disabling any of the sensors you don't have installed on your system.

**RUN**, **END CYCLE**, and **STOP** functions have the same functionality on the Setup Screen as they do on the Control Screen and the Monitors Screen

## Setup Screen

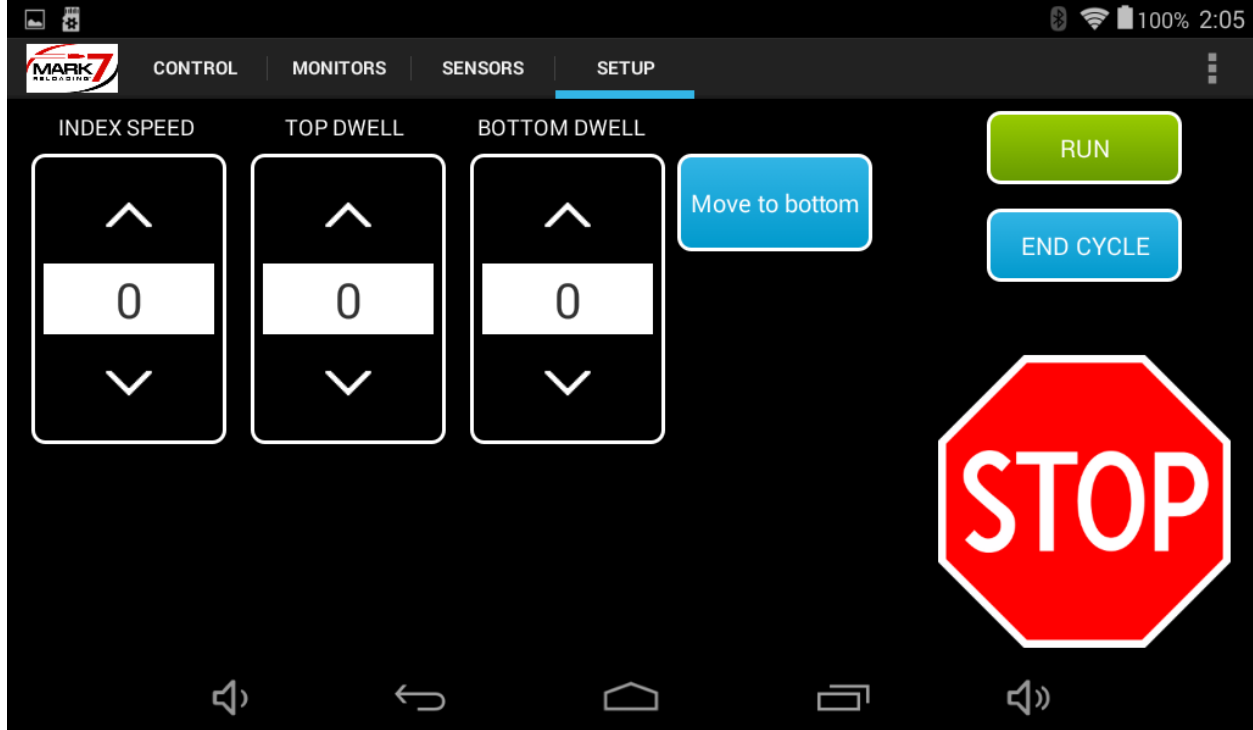

Figure 69: System Setup screen (1050 PRO)

**INDEX SPEED** - The INDEX SPEED function allows the operator the ability to incrementally reduce the index speed of the shell plate. The higher the value in the INDEX SPEED field the slower the shell plate will index.

**TOP DWELL** – The TOP DWELL function allows the operator the ability to add a slight pause at the top of the stroke. This allows for a little extra time for the cases to fully settle before the tool head comes down.

**BOTTOM DWELL** - The BOTTOM DWELL function allows the operator the ability to increase the time in which the press remains at the bottom of the stroke. The higher the value in the BOTTOM DWELL field the longer the press remains at the bottom of the stroke.

**MOVE TO BOTTOM** - This command will move the press head to the bottom of the stroke which is helpful for setting up the dies and adding powder.

**RUN**, **END CYCLE**, and **STOP** functions have the same functionality on the Setup Screen as they do on the Control Screen and the Monitors Screen



## Software and Firmware Update Instructions

1. Download the latest software/firmware from the support section of our website. Installation instructions specific to the update will be included in the downloaded file. These are general update instructions.
2. Unzip the downloaded file and make sure your file manager doesn't change the name of the zipped files or file extensions. This sometimes happens if the same file is downloaded twice or multiple times. Confirm the downloaded files read exactly as shown below:

Firmware: \_\_Mark7\_mot.hex

Software: Mark7Reloader.apk and Firmup.apk\*

\*May only be included in some update packages

3. Inset the Micro SD card into the SD card adapter that was provided with the Mark 7® Autodrive and load the downloaded .hex and .apk file(s) onto the SD card via a SD card reader.
4. Remove the micro SD card from the SD adapter and insert it into the back of the tablet. Make sure the SD is inserted in the orientation shown below with the text facing out.



Figure 70: Orientation of Micro SD card

5. Power on the tablet and the Mark 7® console and clear shell plate; make sure all system cables are fully connected as in normal operation.

6. Select SOFTWARE UPDATE on the main screen then press INSTALL and DONE after the installation is finished. Depending on the software release there may be more than one software application to install. The additional file will automatically launch after the first file is finished.

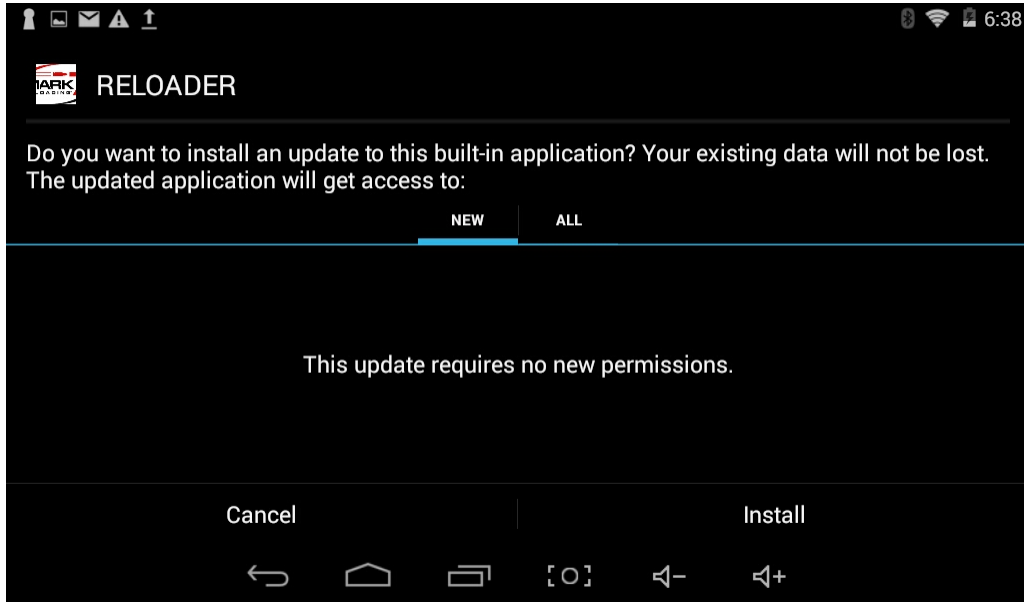

Figure 71: Software installation Screen

7. Once the software has been updated return to the main screen select FIRMWARE UPDATE, then press UPLOAD and press CLOSE when complete. Select the Reloader application and confirm that software version and firmware at the waiver screen is the same as what was just installed.

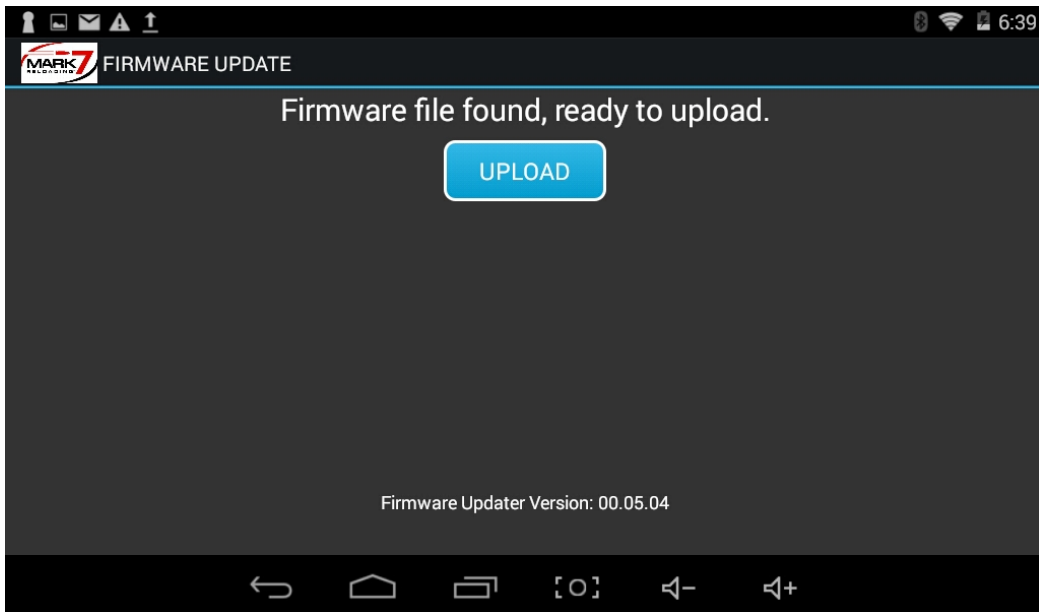

Figure 72: Firmware installation Process



## Troubleshooting: software and firmware updates

**Selecting Firmware update flashes a black screen then goes back to the main screen.**

*Make sure the Mark 7® console is powered on and the USB cable is connected between the tablet and console.*

**Upgrading the firmware takes longer than 5 seconds or freezes.**

*If the firmware installation hangs up, power off the tablet, power off the console then power back on both the tablet and console are try again.*

**Selecting Software and or firmware update says “Insert TF Card” or no “firmware file on card”**

*Make sure the .hex file and .apk file copied correctly on the SD card. If the file extension or file name changed this error message will be displayed.*

**The following Google notification box displays during the software update**

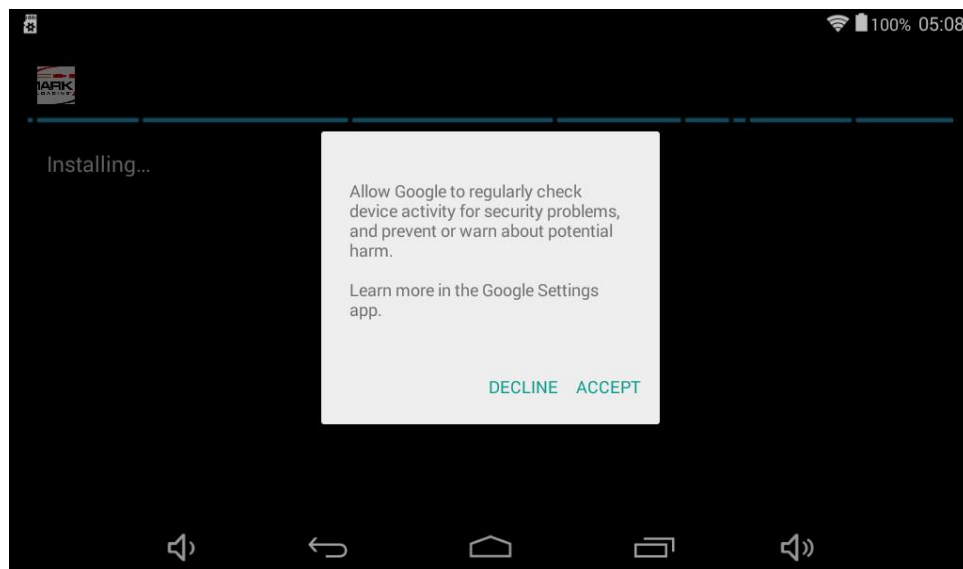

**Figure 73: Google notification**

*If you have enabled wifi on your tablet the above message will appear. Select Accept and continue with the installation. Note: enabling wifi is not necessary for machine operation or for software updates.*



## Mark 7® 1050 Autodrive Maintenance Intervals

The autodrive components are pretty maintenance free. We recommend to periodically check the following areas. Always power off the autodrive when performing maintenance on the machine.

**Belt Tension** - There should be about a ¼' of an inch or less between to the sprockets. The tension needs to be checked with the motor off or you will get an inconsistent measurement.

**Belt Tracking** - The small sprocket mounted to the gearbox shaft is held in place via a set screw locked to the gearbox key. Overtime the set screw may loosen causing the sprocket to “walk” on the gearbox shaft. It’s important to keep an eye on this and re-adjust the sprocket and re-tighten the set screw. This can be achieved by doing the following:

1. Remove the Belt Guard, loosen the motor mount (9/16” socket or wrench) and remove the belt.
2. Rotate the sprocket so the keyway is facing up. Back off the set screw a few turns in order to slide the sprocket freely. The set screw is metric and is either a M4, M5 or M6 (depending on drive model)
3. Reposition the sprocket, tighten the set screw and re-install the belt and belt guard.

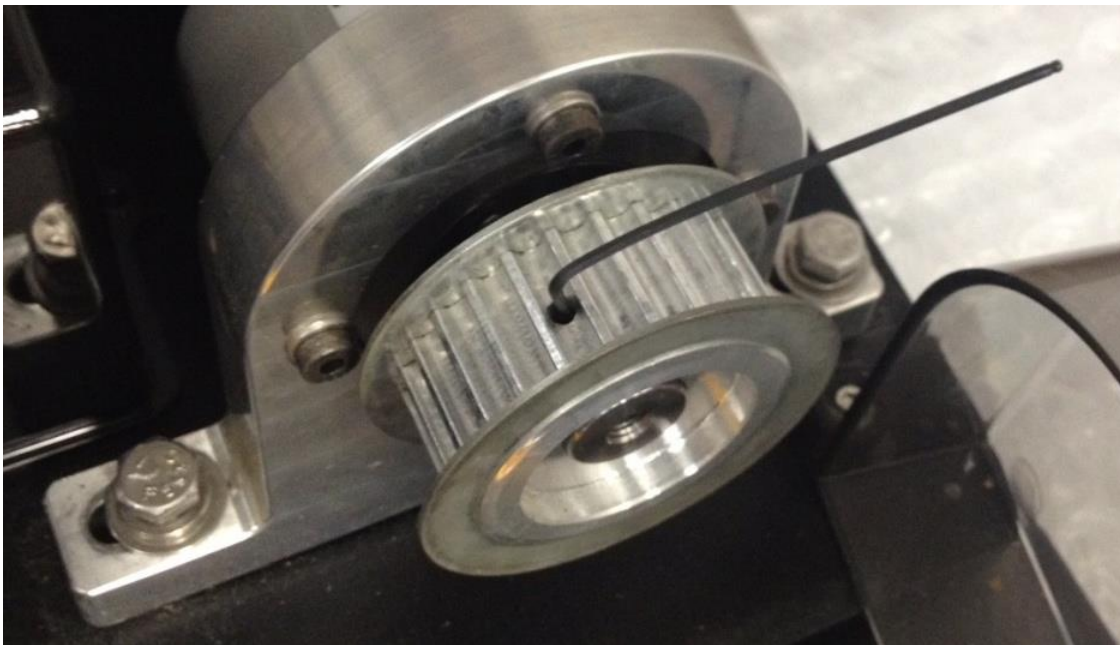

Figure 74: Adjusting the small sprocket position on the gearbox shaft



### Play in the Dillon Crank Assembly

Over time we have seen the ¼ -20 pan head screw back out of the Dillon main shaft. This causes play in the crank assembly. If this goes un-noticed the play will potentially shear off the screw causing a difficult repair to the main shaft. We recommend checking the ¼-20 screw tightness often. For best results replace the ¼-20 screw with a GRADE 8 Hex head screw and apply medium strength Loctite to the thread.

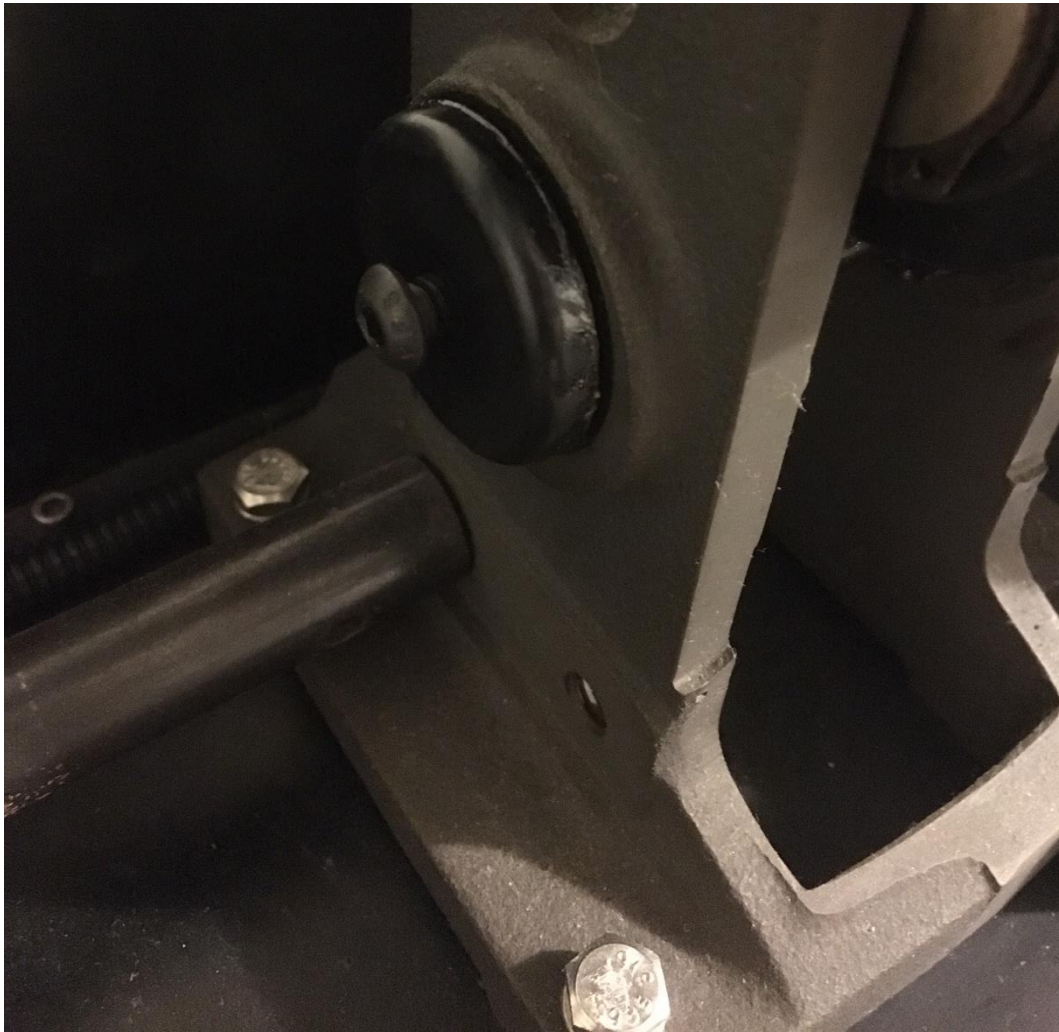

Figure 75: Dillon1050 Super Bearing cap

## Gearbox Shaft Collar Connection

If you have experienced failed calibrations or if the motor seems to lose track of its position within the stroke especially after a jam it's likely the gearbox to motor shaft collar connection has loosened causing the motor to slip. If this is occurring the autodrive will not be functioning properly.

1. To check the connection first identify the 5/8" diameter hole on the side of the gearbox flange at the rear of the autodrive.
2. Remove the plastic cap plugging the hole.

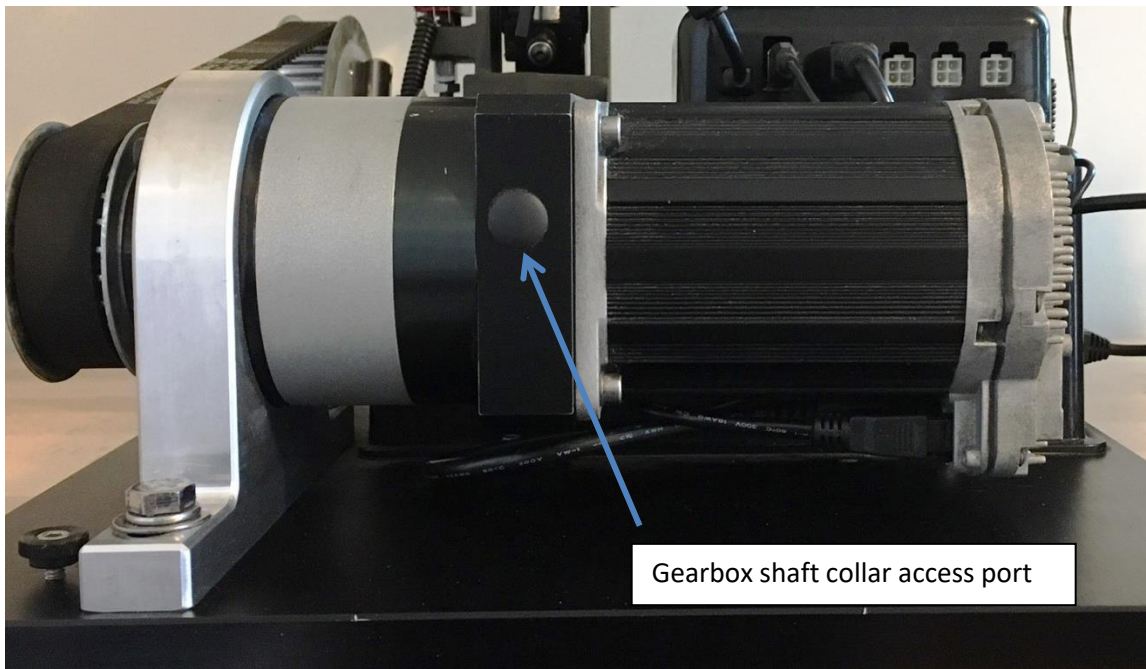
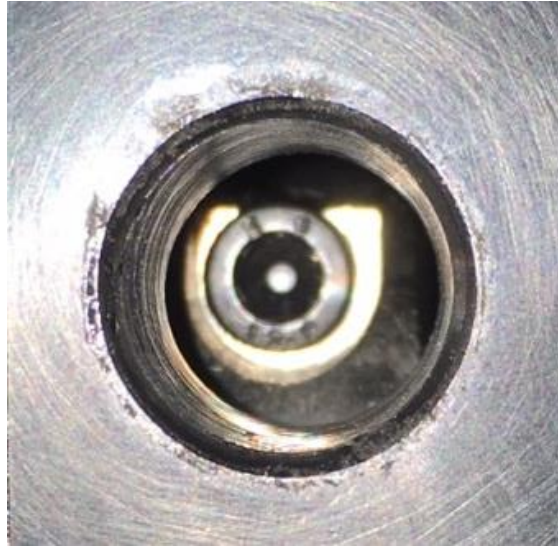

Figure 76: Gearbox Shaft connection

3. Using a light look directly into the hole.
4. While looking into the hole rotate the small sprocket very slowly. You will see the shaft collar spinning inside the hole
5. There are 2X Metric socket head cap screws clamping the gearbox shaft collar to the motor output shaft.



**Figure 77: Socket head cap screw lined up with access hole.**

6. Using an 4MM Allen wrench check both screws for tightness. Using an allen key will not provide enough leverage to fully tighten the connection unless you add more mechanical advantage. We recommend to use a T-handle or ratchet with a deep 4MM Allen socket driver to achieve proper torque.
7. DO NOT over tighten, if they are loose, you will feel it. Make sure the 4 mm Allen is fully seated before tightening, be careful not to strip the socket head screws.

## **Lubrication Points for the Super 1050**

**As recommended by Dillon Precision**

### **1050 Lubrication:**

Operating circumstances will dictate the frequency of required lubrication. It is highly recommended that the Super 1050 be cleaned and lubed after every 10,000 rounds of operation. Use a high-grade, conventional wheel bearing grease – do not use oil.

### **Lubrication Points:**

- Case feed Plunger (#13073\*), lube the sides and bottom.
- Case feed Plunger Roller (#13498) and Bolt (#13333)
- Tappet (#12995)
- Rocker Arm (#13058), cam surfaces and hole.
- Pivot Bolt (#13296)
- Primer Punch Base (#12849 - large or #13307 - small)
- Lube the Indexing Lever Cam surface (#10064) and Index Lever Shoulder Bolt (#13276). With the handle in the rest position, you will see the Index Roller (#10996) come into contact with the Lever Cam



surface. The Index Roller (#10996) also requires periodic lubrication.

- Alignment Pins (#12972 & #13515 located under the tool head)
- Cam Guide Bolt (#12486) and its mated slot
- Tool head Bore (#20420 - lightly to avoid rusting and/or freezing up)
- Mainshaft Lubrication – Use only 30 weight motor oil. DO NOT use a penetrating lubricant such as WD-40, Breakfree, etc...
- Swage Connecting Rod (#13417) and Clevis Pin (#13522)
- Shell plate lock ring (#20311), bottom surface to shell plate face.
- Shell plate center hole. It's easiest to lubricate the shell plate center hole when changing from one caliber to another. We recommend that you use a droplet of Blue Loctite on the threads of the following bolts prior to reinstalling: #13333, #13296, and #13276 (see photos and schematics).

### **Lube Points for the Super 1050: Crank Assembly**

With the handle in the rest position, on the left side of the machine, use a grease syringe to lube the bearing pin (#11009) located in the link arm (#11063). Then, cycle the handle down to the bottom stop. Again, using the grease syringe, lube the mainshaft pivot pin (#10994) on the left side of the machine via the access hole located 1.2" above the carrier cap (#11010).

Use 30 weight motor oil on the mainshaft (#10999).

Towards the back of the machine, lube the indexing lever cam surface (#11064) and index lever shoulder bolt (#13276).

When it is time to lube the roller bearings (#11008) in the frame and crankshaft, first remove the swage rod assembly, swage connecting rod, and operating handle. On the left side of the machine, use a 5/32" Allen wrench to remove the screw (#13685). Slide the carrier cap (#11010) out of its bore and lube the left-hand side roller bearing (#11008) and carrier cap. Next, slide the crankshaft (#11061) out of the frame from the right side of the machine BUT NO MORE THAN 3/4". Using a grease syringe, dispense some grease onto the right-hand side roller bearing (#11008).

Next, lube the crankshaft surface (#11061). Then, reinsert the crankshaft fully into the frame. Reinstall the carrier cap (#11010). Blue Loctite must be used on the threads before installation, tighten. Finally, reassemble the swage component and operating handle back onto the frame. Lube the swage connecting rod (#13417) and clevis pin (#13522)

## **Storage Recommendations**

The following is the proper procedure for storage after a session of use:

1. Ensure that the shell plate is clear of any brass
2. Check the need for lubrication after every session and apply it as necessary at the key lubrication points outlined in the Dillon Precision manual. Insufficient lubrication creates a potentially dangerous situation and may lead to unreliable results
3. Turn off the power to the console of the autodrive
4. Turn off the power to the case feeder and the bullet feeder
5. Turn off the power to the tablet





## Reloading Manual

### Ensuring proper system operation

Before using any Mark 7® equipment you must ensure that your Dillon 1050 works perfectly in manual mode. This includes proper settings for the type of ammunitions you are reloading at each of the die stations. You must load your perfect ammo in manual mode before installing the Mark 7® Autodrive on your 1050.

There is a delicate interaction between the bullet dropper and the amount of brass flair provided by powder funnel. A strategy that may be helpful is to remove the bullet feeder leaving just the bottom portion of the bullet dropper. Loosen the locknut to the powder assembly as well as the two screws holding the bracket in-place under the powder funnel so that you can readily adjust the depth of the powder funnel. Run the machine on slow adjusting both dies until you get the operation you are looking for. You can manually insert bullets into the dropper and single cycle the machine. Make sure that bullets are not toppling over. If so you may need to increase flair and/or increase depth of the dropper mechanism. Once you have run several cycles without issue you can tighten everything up and continue operation.



**WARNING** - Bullets behave differently and in an autodrive setting, small variations in bullet dimensions have unpredictable results in bullet feeding. Take good care that if you are getting results you are not expecting like excessive bullet topple, bullets stuck in the dropper, etc.

### Calibration

Calibration can only be done when the Mark 7® Autodrive is empty with no casings in the shell plate. Only after calibration is complete you may start reloading ammunition

### Test Rounds

Once calibration is completed, and you have loaded the shell plate with brass you must take the first round produced and remove it. Take the next two rounds and check the measurements with high quality calipers. Adjust dies if necessary and repeat to ensure that setting meet the specifications that you are loading.

## Digital Clutch Setting

The Digital Clutch adjusts the torque of the motor from the minimum torque required to drive the press to the maximum torque of the motor. This range is from 0-20 or (LOW-MAX) on the tablet main control screen. For 1050 X and PRO models it is important to note that increasing the Digital Clutch only increases the motor torque when the tool head is in the down stroke approaching the shell plate (for sizing/decapping/bullet seating/crimping operations). When the tool head retracts the torque is hard programmed at the minimum level to maximize jam sensitivity and to best protect the components of the 1050 Super and RL presses.



Figure 78: Digital Clutch Adjustment on control screen

1. All Mark7® Autodrives are shipped with the Digital Clutch at 0 or LOW (LTE). This is the minimum torque required to run the press dry (without components).
2. When you are ready to process brass or reload once fired brass use the following table as a guide for starting torque levels. Always use lubed brass in order to run the Digital Clutch as low as possible. Depending on the condition of the brass you may be able to run the machine on lower settings than listed below. We recommend running the machine on the lowest Digital Clutch setting possible for the given caliber.

Table 1: Recommend Digital Clutch settings for general calibers

Small Pistol	Large Pistol	Small Rifle	Large Rifle
2-5	3-10	5-12	12-20

3. If the Digital Clutch is set to low for a given operation the following notification will appear on the tablet usually close to the bottom of the stroke when the sizing/decap die is engaged. If you don't get a notification make sure you have software 00.01.02 (9/27/2016) or newer.

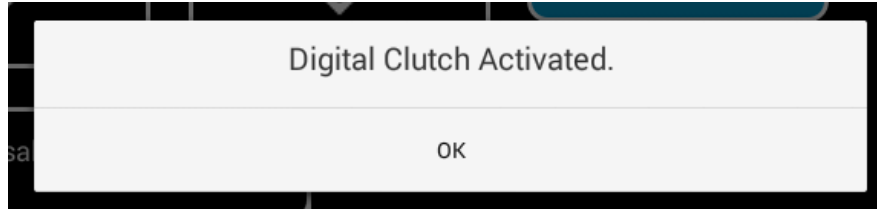

Figure 79: Digital clutch notification

4. Sometimes pressing RUN again will provide enough torque to push through the sizing operation. If the notification box appears again the clutch will need to be increased and or check for a hard jam causing the torque out condition.
5. Double Tap STOP to put the motor and neutral and to reset the motor.
6. Next JOG tool head up and inspect the shell plate area for a jam. If everything looks okay increase the Digital Clutch by a 1-2 digits then press RUN or END CYLCE. Repeat the process until the machine pushes through and completes the stroke.
7. Continue to run at the new Digital Clutch setting until you get consistent stroke cycle completion.

#### Special Notes:

- The Digital Clutch is speed dependent; you may need to slightly increase the Digital Clutch as you increase the speed of the drive.
- Use caution when operating the machine with a Digital Clutch over 15 or HIGH.
- Always use Lubed brass for best results and to allow running on the lowest clutch setting possible.
- Check for proper belt tension and for play in the crank assembly regularly.
- When clearing jams always check and or clear the case in station #5 (powder) to avoid a double or no charge before continuing.

## JAMSense® - Clearing Jams

When a jam occurs the motor will stop and a notification on the tablet will appear saying *Digital Clutch Activated*. It's important to note that this message may not always mean there is a jam in the press, sometimes motor may have just torqued out due to the Digital Clutch being set too low for a given operation.

We recommend taking the following steps when a jam occurs.

1. Inspect the tool head and shell plate area of the press to determine the cause of stoppage.
2. Press STOP twice to put the motor in neutral (the LED on the back of the orange will change from green to orange in this state)
3. If you are able to determine the cause of the jam or stoppage, Use the JOG commands to back off the **toolhead** in order to rectify the issue. Once cleared hit RUN to continue as normal.
4. If you are not able to determine the cause of the jam, manually actuate the large sprocket by using a 5/8" wrench. Once the jam is clear perform a full stroke manually before continuing.

In some cases a hard jam may occur. If the jog buttons do not move the tool head then the Mark 7<sup>®</sup> Autodrive needs to be powered down. Once powered down may attempt to manually clear the jam. In doing so you must clear the shell plate and confirm that the press can manually index. Run the full cycle of the machine a couple of times by manipulating the belt manually and ensure the machine is in good working order. Then you can repower the machine and continue.



**WARNING** -Never attempt to clear a jam by placing your fingers in the mechanism of the Mark 7<sup>®</sup> Autodrive. Always ensure that the Mark 7<sup>®</sup> Autodrive is off and power is cut off to the Mark 7<sup>®</sup> Autodrive before attempting to clear a jam.

If you experience a jam or any type of activity that requires you to turn off the Mark 7<sup>®</sup> Autodrive at the console, you may decide or be required to calibrate the Mark 7<sup>®</sup> Autodrive again. Always repeat the process of ensuring that the measurements on your brass or ammunition are that same that they were in your previous calibration – they will likely be within acceptable tolerances.

## Settings

There are a number of settings that your Mark 7<sup>®</sup> Mark 7<sup>®</sup> Autodrive came with. They include: Production rate, digital clutch, dwell, index speed. You can experiment with different settings to ensure that you are making the highest quality ammunition



**WARNING** - It is up the user to develop the right kind of settings to support the particular type of operation that they are undertaking.



## Communications Errors

If you see the following communication error (USB Disconnected) on the tablet when you are running the machine it is caused by electrical interference or a bad tablet USB connection.

**Please follow these steps to minimize electrical interference from external reloading devices that contain motors:**

- Check USB connection between tablet and Console is secure
- Install the Mr.Bulletfeeder and Dillon case feeder filter included with the system.
- Route the Dillon power cord and Mr.Bulletfeeder power cables away from tablet USB and power cords. Do not zip tie the Dillon Power cord to the 1050 case feeder pole.
- Power the Mr.Bulletfeeder & Dillon case feeder on their own surge protector if possible.
- Make sure the USB connectors are secure and away from the moving 1050 components.
- Check your electrical grounds, grounding the machine to an independent true earth ground is recommended.

In the event of this error you must clear the shell plate from all brass, rectify the situation above that caused the error, turn on the machine, proceed with calibration, and restart your operation.

If this error occurs during machine operation and you have followed the above steps please contact us for technical support.



## Troubleshooting

Refer to the knowledge base section on our website under **SUPPORT** for troubleshooting articles relating to setup and operation.

<http://www.markvii-loading.com/>

### **Please contact us for technical support**

Phone: 1-239-349-7266

Hours: 8:00am-5:00pm, ET, M-F

CRM: <https://www.markvii-loading.com/crm.asp?action=contactus>